



2018 Game & Season Manual

FIRST[®] **POWER** **UP**SM

www.firstinspires.org

200 BEDFORD STREET ■ MANCHESTER, NH 03101



FOR INSPIRATION & RECOGNITION OF SCIENCE & TECHNOLOGY



FIRST®, the *FIRST*® logo, *FIRST*® Robotics Competition, *Coopertition*®, *FIRST POWER UP*™, *Gracious Professionalism*®, and Sport for the Mind™ are trademarks of For Inspiration and Recognition of Science and Technology (*FIRST*®). © 2017-2018 *FIRST*. All rights reserved.

Official *FIRST*® Robotics Competition teams and Partners are permitted to make reproductions of this manual for team and Partner use only. Any use, reproduction, or duplication of this manual for purposes other than directly by the team or Partner as part of *FIRST*® Robotics Competition participation is strictly prohibited without specific written permission from *FIRST*. This manual may not be re-hosted without specific written permission from *FIRST*.

www.firstinspires.org

200 BEDFORD STREET ■ MANCHESTER, NH 03101



FOR INSPIRATION & RECOGNITION OF SCIENCE & TECHNOLOGY

Contents

2018 Game & Season Manual.....	1
Contents.....	iii
1 Introduction.....	7
1.1 About FIRST.....	7
1.2 FIRST® Robotics Competition.....	7
1.3 Gracious Professionalism®, a FIRST® Credo.....	7
1.4 Coopertition®.....	8
1.5 This Document and its Conventions.....	9
1.6 Translations & Other Versions.....	10
1.7 Team Updates.....	10
1.8 Question and Answer System.....	11
2 FIRST® POWER UP® Overview.....	13
3 ARCADE.....	15
3.1 Zones and Markings.....	16
3.2 FIELD.....	17
3.2.1 GUARDRAIL.....	17
3.3 SCALE.....	18
3.3.1 SCALE PLATES.....	19
3.3.2 RUNGS.....	22
3.3.3 OUTRIGGERS.....	22
3.3.4 TOWER.....	22
3.3.5 PLATFORM.....	23
3.4 SWITCH.....	24
3.4.1 SWITCH PLATES.....	24
3.4.2 FENCE.....	25
3.5 PLATE Lighting.....	26
3.6 ALLIANCE WALL.....	28
3.6.1 PLAYER STATION.....	28
3.6.2 EXCHANGE.....	29
3.6.3 VAULT.....	29
3.7 PORTAL.....	32
3.8 POWER CUBE.....	33
3.9 Vision Targets.....	33
3.10 The FIELD Management System.....	34
4 MATCH Play.....	37



4.1.1	Stages.....	37
4.1.2	MATCH Setup.....	38
4.2	Scoring.....	39
4.3	POWER UPS.....	41
4.4	Rule Violations.....	43
4.5	DRIVE TEAM.....	43
4.6	Logistics.....	44
5	Safety Rules.....	45
6	Conduct Rules.....	47
7	Game Rules.....	51
7.1	Before the MATCH.....	51
7.2	ROBOT Restrictions.....	52
7.3	ROBOT to ROBOT Interaction.....	54
7.4	FIELD Interaction.....	56
7.5	AUTO Period Rules.....	60
7.6	Human Action Rules.....	60
8	ROBOT Rules.....	64
8.1	Overview.....	64
8.2	General ROBOT Design.....	66
8.3	ROBOT Safety & Damage Prevention.....	68
8.4	Budget Constraints & Fabrication Schedule.....	69
8.5	BUMPER Rules.....	75
8.6	Motors & Actuators.....	83
8.7	Power Distribution.....	86
8.8	Control, Command & Signals System.....	92
8.9	Pneumatic System.....	96
8.10	OPERATOR CONSOLE.....	101
9	Inspection & Eligibility Rules.....	103
10	Tournaments.....	107
10.1	MATCH Schedules.....	107
10.2	Practice MATCHES.....	107
10.2.1	Filler Line.....	107
10.3	Measurement.....	108
10.4	Qualification MATCHES.....	108
10.4.1	Schedule.....	108
10.4.2	MATCH Assignment.....	108
10.4.3	Qualification Ranking.....	109



10.5	Playoff MATCHES	109
10.5.1	ALLIANCE Selection Process.....	110
10.5.2	BACKUP TEAMS.....	111
10.5.3	Playoff MATCH Bracket	111
10.6	REFEREE Interaction	113
10.7	YELLOW and RED CARDS	114
10.8	MATCH Replays	115
10.9	TIMEOUTS and BACKUP TEAMS	116
10.10	Pit Crews	117
10.11	FIRST Championship Additions and Exceptions	118
10.11.1	Four ROBOT ALLIANCES.....	118
10.11.2	FIRST Championship Pit Crews.....	119
10.11.3	FIRST Championship Playoffs.....	119
10.11.4	FIRST Championship TIMEOUTS.....	120
10.12	Advancement Between Tournaments	120
10.12.1	Regional Events.....	121
10.12.2	Mild Cards.....	121
10.12.3	District Events.....	122
11	Glossary	129



1 Introduction

1.1 About *FIRST*[®]

FIRST[®] (For Inspiration and Recognition of Science and Technology) was founded by inventor Dean Kamen to inspire young people's interest in science and technology. Based in Manchester, New Hampshire, *FIRST* is a 501(c)(3) not-for-profit public charity.

FIRST provides four programs:

- *FIRST*[®] Robotics Competition for grades 9-12, ages 14-18
- *FIRST*[®] Tech Challenge for grades 7-12, ages 12-18
- *FIRST*[®] LEGO[®] League for grades 4-8, ages 9-14 (ages 9-16 outside of North America)
- *FIRST*[®] LEGO[®] League Jr. for grades K-4, ages 6-10

Please visit our website: www.firstinspires.org for more information about *FIRST* programs.

1.2 *FIRST*[®] Robotics Competition

FIRST Robotics Competition pairs high school students with adult mentors (primarily engineers and teachers) to design and build ROBOTS that compete against one another in a high-energy environment.

This varsity *Sport for the Mind*[™] combines the excitement of sport with the rigors of science and technology. Under strict rules, limited resources and time limits, teams of students are challenged to raise funds, design a team "brand," hone teamwork skills, and build and program ROBOTS to perform prescribed tasks against a field of competitors. It's as close to "real-world" engineering as a student can get.

Each January at an event known as "Kickoff," a new, challenging game is introduced. These exciting competitions combine the practical application of science and technology with the fun, intense energy and excitement of a championship-style sporting event. Teams are encouraged to display *Gracious Professionalism*[®], help other teams, and cooperate while competing. This is known as *Coopertition*[®].

In 2018, *FIRST* Robotics Competition will reach 90,000 high-school students representing more than 3,600 teams. Teams come from nearly every state in the United States, as well as many other countries.

FIRST Robotics Competition teams will participate in 63 Regional Competitions, 85 District Competitions, and 10 District Championships. In addition, approximately 800 teams will qualify to go to one of the two *FIRST* Championships at the end of April, 2018.

This year's game, and this manual, were presented at the 2018 *FIRST* Robotics Competition Kickoff on Saturday, January 6, 2018.

At the Kickoff, all teams:

- saw the 2018 game, *FIRST*[®] POWER UPSM, for the first time
- learned about the 2018 game rules and regulations
- received a Kickoff Kit that provides a starting point for robot build

1.3 *Gracious Professionalism*[®], a *FIRST*[®] Credo

Gracious Professionalism[®] is part of the ethos of *FIRST*. It's a way of doing things that encourages high quality work, emphasizes the value of others, and respects individuals and the community.

Gracious Professionalism is not clearly defined for a reason. It can and should mean different things to everyone.

Some possible meanings of *Gracious Professionalism* include:

- Gracious attitudes and behaviors are win-win
- Gracious folks respect others and let that respect show in their actions
- Professionals possess special knowledge and are trusted by society to use that knowledge responsibly
- Gracious Professionals make a valued contribution in a manner pleasing to others and to themselves

In the context of *FIRST*, this means that all teams and participants should:

- Learn to be strong competitors, but also treat one another with respect and kindness in the process
- Avoid leaving anyone feeling as if they are excluded or unappreciated

Knowledge, pride and empathy should be comfortably and genuinely blended.

In the end, *Gracious Professionalism* is part of pursuing a meaningful life. When professionals use knowledge in a gracious manner and individuals act with integrity and sensitivity, everyone wins and society benefits.

“The FIRST spirit encourages doing high-quality, well-informed work in a manner that leaves everyone feeling valued. Gracious Professionalism seems to be a good descriptor for part of the ethos of FIRST. It is part of what makes FIRST different and wonderful.”

- Dr. Woodie Flowers, National Advisor for FIRST



It is a good idea to spend time going over this concept with your team and reinforcing it regularly. We recommend providing your team with real-life examples of *Gracious Professionalism* in practice, such as when a team loans valuable materials or expertise to another team that they will later face as an opponent in competition. Routinely highlight opportunities to display *Gracious Professionalism* at events, and encourage team members to suggest ways in which they can demonstrate this quality themselves and through outreach activities.

1.4 Coopertition®

At *FIRST*, *Coopertition*® is displaying unqualified kindness and respect in the face of fierce competition. *Coopertition* is founded on the concept and philosophy that teams can and should help and cooperate with one another even as they compete. *Coopertition* involves learning from teammates and mentors. *Coopertition* means competing always, but assisting and enabling others when you can.

A Message from Woodie Flowers Award Recipients

The Woodie Flowers Award is the most prestigious mentoring award in *FIRST*. The award recipients as of the 2015 *FIRST* Championship created an important message for all *FIRST* Robotics Competition teams to consider as we tackle each season.

“Performing at your best is important. Winning is important. This is a competition.

However, winning the right way and being proud of what you have accomplished and how you have accomplished it is more important. *FIRST* could create rules and penalties to cover almost any scenario



or situation, but we prefer an understandable game with simpler rules that allow us to think and be creative in our designs.

We want to know that our partners and opponents are playing at their best in every match. We want to know they are playing with integrity and not using strategies based on questionable behaviors.

As you create your robots and award presentations, prepare for competition and match play, create and implement game strategies, and live your daily lives, remember what Woodie has said time and time again, and let's 'Make your Grandmother proud.'"

Woodie Flowers

Liz Calef (88)

Mike Bastoni (23)

Ken Patton (51, 65)

Kyle Hughes (27)

Bill Beatty (71)

Dave Verbrugge (5110, 67)

Andy Baker (3940, 45)

Dave Kelso (131)

Paul Copioli (3310, 217)

Rob Mainieri (2735, 812, 64)

Dan Green (111)

Mark Breadner (188)

John Novak (16, 323)

Chris Fultz (234)

John Larock (365)

Earl Scime (2614)

Fredi Lajvardi (842)

Lane Matheson (932)

Mark Lawrence (1816)

Eric Stokely (258, 360, & 2557)

Glenn Lee (359)

1.5 This Document and its Conventions

The **2018 Game and Season Manual** is a resource for all *FIRST* Robotics Competition teams for information specific to the 2018 season and the *FIRST*[®] POWER UPSM game. Its audience will find the following detail:

- a general overview of the *FIRST* POWER UP game
- detail about the *FIRST* POWER UP playing field
- description of how to play the *FIRST* POWER UP game
- all season rules (e.g. safety, conduct, game play, inspection, etc.)
- description of how teams advance at 2018 tournaments and throughout the season


The intent of this manual is that the text means exactly, and only, what it says. Please avoid interpreting the text based on assumptions about intent, implementation of past rules, or how a situation might be in "real life." There are no hidden requirements or restrictions. If you've read everything, you know everything.

Specific methods are used throughout this section to highlight warnings, cautions, key words and phrases. These conventions are used to alert the reader to important information and are intended help teams in constructing a ROBOT that complies with the rules in a safe manner.

Links to other section headings in this manual and external articles appear in [blue underlined text](#).

Key words that have a particular meaning within the context of the *FIRST* Robotics Competition and *FIRST* POWER UP are defined in [Section 11 Glossary](#), and indicated in ALL CAPS throughout this document.

The rule numbering scheme uses an indication of the section in which the rule is stated plus a serial numbering system (e.g. safety rules begin with "S," game rules begin with "G," etc.). References to specific rules use this scheme (e.g. "**S01**" is the first rule in [Section 5 Safety Rules](#)).



Warnings, cautions and notes appear in blue boxes. Pay close attention to their contents as they're intended to provide insight into the reasoning behind a rule, helpful information on understanding or interpreting a rule, and/or possible “best practices” for use when implementing systems affected by a rule.

While blue boxes are part of the manual, they do not carry the weight of the actual rule (if there is an inadvertent conflict between a rule and its blue box, the rule supersedes the language in the blue box).

With the exception of nominal dimensions, imperial dimensions are followed by comparable metric dimensions in parentheses to provide metric users with the approximate size, weight, etc. Metric conversions for non-rules (e.g. FIELD dimensions) round to the nearest whole unit e.g. "17 in. (~43 cm)" and "6 ft. 4 in. (~193 cm)." Metric conversions in rules round such that the metric dimension is compliant with the rule (i.e. maximums round down, minimums round up). The metric conversions are offered for convenient reference only and do not overrule or take the place of the imperial dimensions presented in this manual and the field drawings (i.e. FIELD dimensions and rules will always defer to measurements using imperial units).

Some sections and rules include colloquial language, also called headlines, in an effort to convey an abbreviated intent of the rule or rule set. This language is differentiated **using bold blue text**. Any disagreement between the specific language used in the rules and the colloquial language is an error, and the specific rule language is the ultimate authority. If you discover a disparity, please [let us know](#) and we will correct it.

Team resources that aren't generally season specific (e.g. what to expect at an event, communication resources, team organization recommendations, ROBOT transportation procedures, and award descriptions) can be found on the [FIRST Robotics Competition website](#).

1.6 Translations & Other Versions

The *FIRST*[®] POWER UPSM manual is originally and officially written in English, but is occasionally translated into other languages for the benefit of *FIRST* Robotics Competition Teams whose native language may not be English.

A text-based version can be provided only for use with assistive devices for visually and hearing-impaired persons, and not for redistribution. For more information, please contact frcteamadvocate@firstinspires.org.

In the event that a rule or description is modified in an alternate version of this manual, the English pdf version as published on the *FIRST* website is the commanding version.

1.7 Team Updates

Team updates are used to notify the *FIRST* Robotics Competition community of revisions to the official season documentation (e.g. the manual, drawings, etc.) or important season news. Between Kickoff and Stop Build Day, Team Updates are posted each Tuesday and Friday. Between Stop Build Day and the week before *FIRST* Championship Houston, Team Updates are posted each Tuesday. Team updates are posted on the [FIRST[®] POWER UPSM Game and Season Materials website](#) and generally posted before 5 pm, Eastern Time.

Generally, Team Updates follow the following convention:

- Additions are highlighted in yellow. **This is an example.**



- Deletions are indicated with a strikethrough. ~~This is an example.~~
- Notes that are added for clarity or explanation for the change but are not retained as part of the manual appear in bold. **This is an example.**

1.8 Question and Answer System

Questions about any **2018 Game and Season Manual** content and [FIRST® Robotics Competition Event Experience web page](#) content may be asked to FIRST using the official [Question and Answer System](#) (i.e. “the Q&A”), which opens on January 10, 2018, noon Eastern. Details on the Q&A can be found on the [FIRST® POWER UPSM Game and Season Materials website](#). The Q&A is intended to help clarify rules, and sometimes the responses result in revisions to the text in the official document (which is communicated using [Team Updates](#)).

The Q&A is not a resource for

- rulings on hypothetical strategies or vague situations,
- challenging decisions made at past events, or
- design reviews of a ROBOT system for legality.

The responses in the Q&A do not supersede the text in the manual, although every effort will be made to eliminate inconsistencies between the two. While responses provided in the Q&A may be used to aid discussion at each event, per [Section 10.6 REFEREE Interaction](#) and [Section 9 Inspection & Eligibility Rules](#), REFEREES and Inspectors are the ultimate authority on rules. If you have concerns about enforcement trends by volunteer authorities, please notify FIRST at firstroboticscompetition@firstinspires.org.

Weak questions are overly broad, vague, and/or include no rule references. Some examples of questions that will not be answered in the Q&A are:

- Is this part/design legal?
- How should the REFEREE have ruled when this specific game play happened?

Good questions ask generically about features of parts or designs, gameplay scenarios, or rules, and often reference one or more relevant rules within the question. Some examples of questions that will likely be answered in the Q&A are:

- A device we are considering using on the robot comes with purple AWG 40 wire, does this comply with R?? and R??
- We're not sure how to interpret how Rule G?? applies if Blue Robot A does X and Red Robot B does Y, can you please clarify?



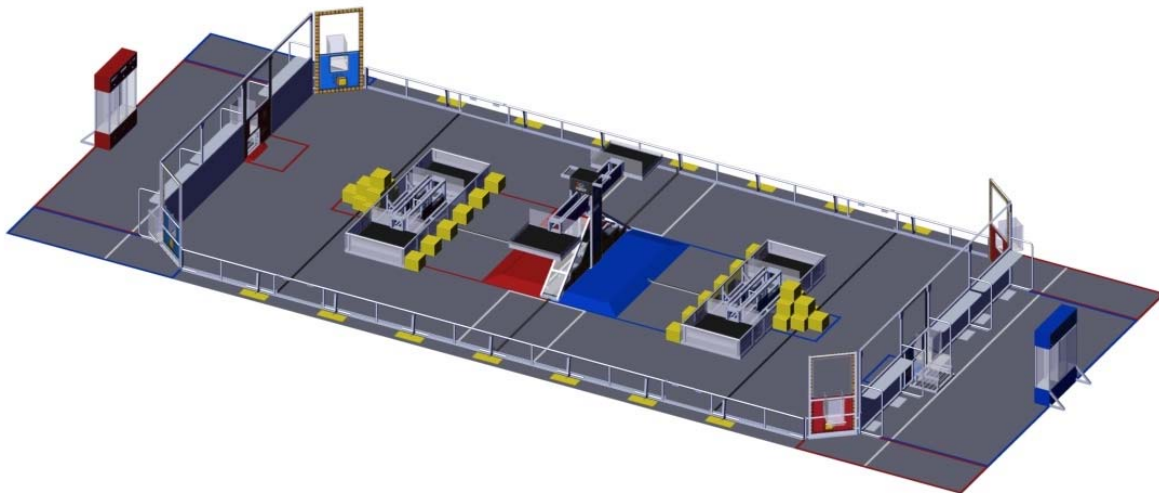
2 FIRST® POWER UPSM Overview

FIRST® POWER UPSM, the 2018 FIRST® Robotics Competition game, includes two alliances of video game characters and their human operators who are trapped in an arcade game. Both alliances are working to defeat the boss in order to escape!

Each three-team alliance prepares to defeat the boss in three ways:

- 1. Control the Switches and the Scale.** Robots collect Power Cubes and place them on Plates to control Switches or the Scale. When the Scale or their Switch is tipped in their favor, it is considered owned by that Alliance. Alliances work to have Ownership for as much time as possible.
- 2. Earn Power Ups.** Robots deliver Power Cubes to their humans who then place them into the Vault earning the Alliance Power Ups. Alliances use Power Ups to gain a temporary advantage during the Match. There are three Power Ups available to teams: Force, Boost, and Levitate.
 - Force gives the alliance ownership of the Switch, Scale, or both for a limited period of time
 - Boost doubles the rate points are earned for a limited period of time
 - Levitate gives a robot a free climb
- 3. Climb the Scale.** Robots Climb the Scale in order to be ready to Face The Boss.

Figure 2-1: FIRST® POWER UPSM playing area



SOLIDWORKS
Modeling Solutions Partner

Each match begins with a 15-second Autonomous period in which Robots operate only on pre-programmed instructions. During this period, Robots work to support the three efforts listed above as well as earn points for crossing their Auto Line.



Table 2-1: Autonomous Point Values

Action	Value
Cross the Auto Line (a.k.a Auto-Run)	5 points
Switch Ownership	2, + 2 points per second
Scale Ownership	2, + 2 points per second

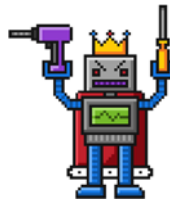
During the remaining 2 minutes and 15 seconds of the match, the Teleoperated period, student drivers control Robots. Teams on an Alliance work together to continue to control their Switch and the Scale. They can also trade in their Power Cubes for Power Ups. During the final 30 seconds, teams work together to Climb to Face the Boss. Points for these efforts are awarded as shown in Table 2-2.

Table 2-2: Teleoperated Point Values

Action	Value
Switch Ownership	1, + 1 point per second
Scale Ownership	1, + 1 point per second
Power Cube in Vault	5 points
Boost Power Up Bonus	2 points per second
Parked on Platform	5 points
Successful Climb	30 points

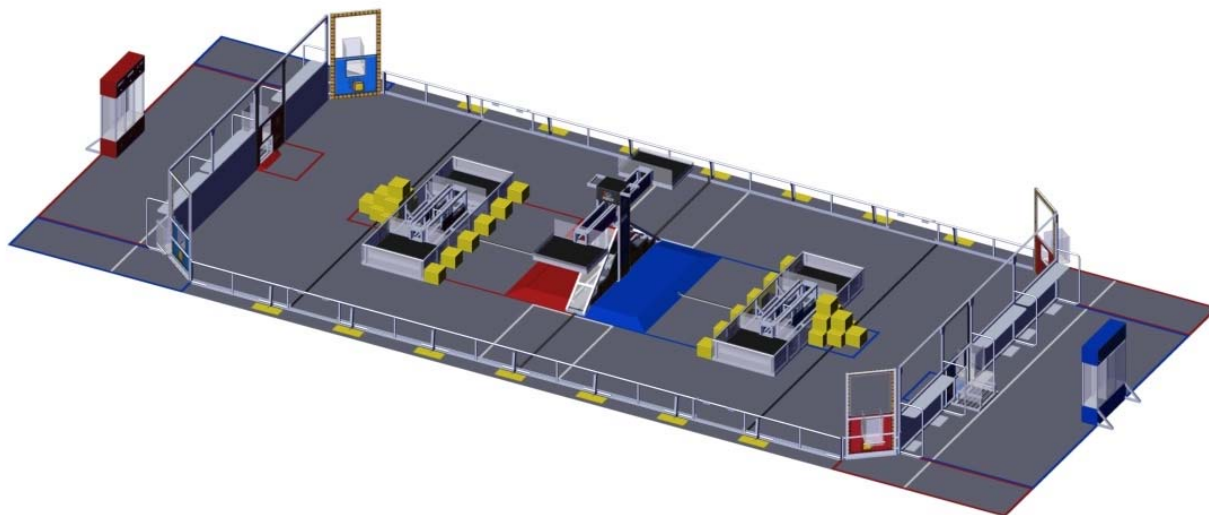
Alliances are seeded in the Qualification tournament using ranking points which are awarded based on a combination of their Win-Loss-Tie record (2 points for a win, 1 point for a tie), the number of times they achieve three Climbs (1 point), and the number of times during Autonomous they complete three Auto-Runs and gain Ownership of their Switch (a.k.a the Auto-Quest) (1 point).

For full details, read on!



3 ARCADE

Figure 3-1: FIRST® POWER UPSM playing area



The ARCADE includes all elements of the game infrastructure that are required to play *FIRST® POWER UPSM*: the FIELD, SWITCHES, the SCALE, VAULTS, carpet, the POWER CUBES, and all equipment needed for FIELD control, ROBOT control, and scorekeeping.

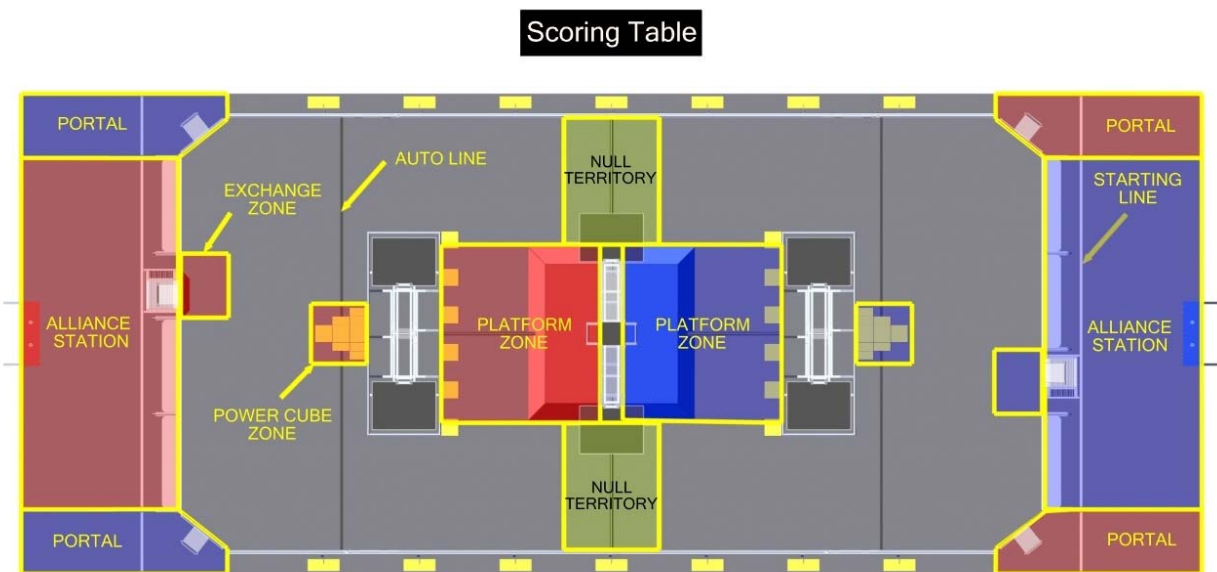
The competition ARCADE is modular and assembled, used, disassembled, and shipped many times during the competition season. It will undergo wear and tear. The ARCADE is designed to withstand rigorous play and frequent shipping. Every effort is made to ensure that ARCADES are consistent from event to event. However, ARCADES are assembled in different venues by different event staff and some small variations occur. For details regarding assembly tolerances, please refer to the [2018 ARCADE Layout and Marking Drawing](#). Successful Teams will design ROBOTS that are insensitive to these variations.

Illustrations included in this section are for a general visual understanding of the *FIRST® POWER UPSM* ARCADE, and dimensions included in the manual are nominal. Please refer to the official drawings for exact dimensions, tolerances, and construction details. The official drawings, CAD models, and drawings for low-cost versions of important elements of the *FIRST® POWER UPSM* FIELD are posted on the [2018 FIRST® POWER UPSM Game & Season Materials page](#) on the *FIRST®* website.

3.1 Zones and Markings

- ALLIANCE STATION: a 22 ft. (~671 cm) wide by 10 ft. (~305 cm) deep by 10 ft. (~305 cm) tall volume formed by, and including three (3) PLAYER STATIONS, an EXCHANGE wall, and 2 in. ALLIANCE colored gaffers tape.
- AUTO LINE: a line of 2 in. (~5 cm), black gaffers tape that is the width of the FIELD and is 10 ft. (~305 cm) from each ALLIANCE WALL to the leading edge of the tape.
- EXCHANGE ZONE: A rectangular area 4 ft. (~122 cm) wide by 3 ft. (~91 cm) deep and infinitely tall volume bounded by the EXCHANGE wall and 2 in. (~5 cm) ALLIANCE colored gaffers tape. The EXCHANGE ZONE includes the tape, but excludes the wall.
- NULL TERRITORY: one of two, 7 ft. 11 ¼ in. (~242 cm) wide by 6 ft. (~183 cm) deep and infinitely tall volumes formed by 2 in. (~5 cm), white gaffers tape and the GUARDRAILS. The NULL TERRITORY includes the gaffers tape, but excludes the GUARDRAILS. The ALLIANCE'S NULL TERRITORY for a MATCH corresponds to the SCALE PLATE color in that NULL TERRITORY and does not change when the FORCE POWER UP is played.
- PLATFORM ZONE: a 11 ft. 1 ½ in. (~339 cm) wide by 9 ft. 11 ¼ in. (~304 cm) deep and infinitely tall volume bounded by 2 in. (~5 cm) ALLIANCE colored gaffers tape, the faces of the OUTRIGGERS, TOWER, and the SWITCH. The PLATFORM ZONE includes the gaffers tape, but excludes the SWITCH and the faces of the OUTRIGGERS AND TOWER.
- PORTAL: a 4 ft. (~122 cm) wide by 12 ft. 11 in. (~394 cm) deep infinitely tall volume bounded by, and including, 2 in. (~5 cm). ALLIANCE colored gaffers tape and the PORTAL wall.
- POWER CUBE ZONE: A rectangular area 3 ft. 9 in. (~114 cm) wide by 3 ft. 6 in. (~107 cm) deep, bounded by the SWITCH and 2 in. (~5 cm) ALLIANCE colored gaffers tape. The POWER CUBE ZONE includes the gaffers tape, but excludes the SWITCH.
- STARTING LINE: a line of 2 in. (~5 cm), white gaffers tape that runs the width of the carpet and is 2 ft. 6 in. (~76 cm) behind the ALLIANCE WALL diamond plate, which includes the tape.

Figure 3-2: Zones and Markings



SOLIDWORKS
Modeling Solutions Partner

3.2 FIELD

The FIELD for *FIRST*® POWER UPSM is a 27 ft. (~823 cm) by 54 ft. (~1646 cm) carpeted area, bound by and including the inward-facing surfaces of the GUARDRAILS, PORTALS, EXCHANGE walls and ALLIANCE WALLS. The carpet used for the FIELD is gray in color (Shaw Floors, Philadelphia Commercial, Neyland II 20, “Ground Pepper”).

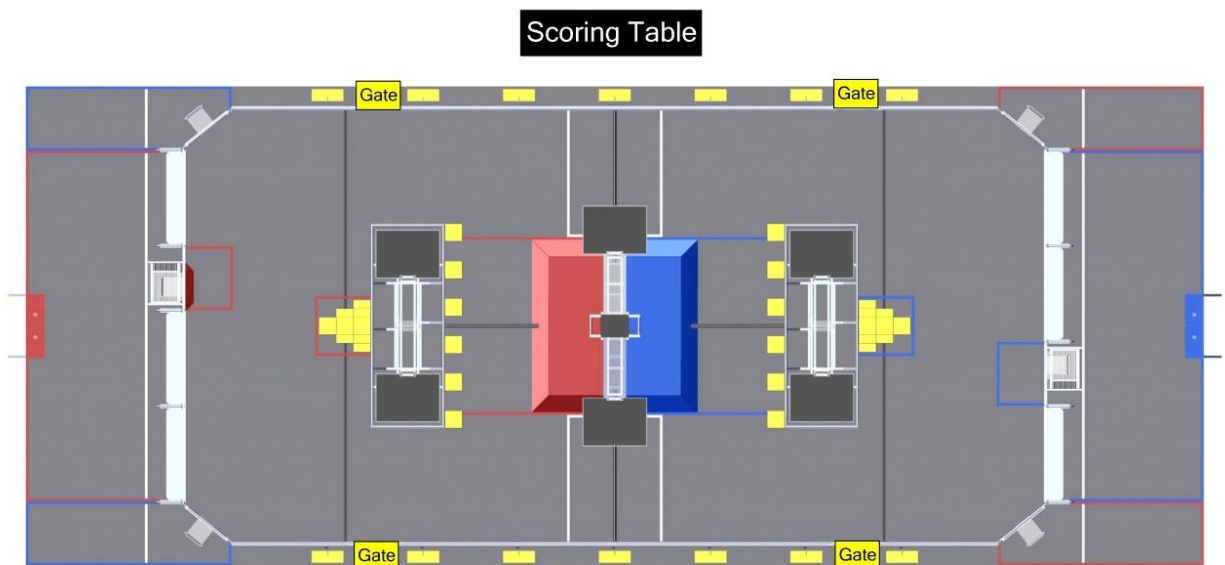
There are two versions of GUARDRAILS and PLAYER STATIONS used for competitions. One design has been used at *FIRST*® Robotics Competitions for several years and matches the 2018 Official *FIRST* Field Drawings & Models. The other is designed and sold by AndyMark. While the designs are slightly different, the critical dimensions, performance, and expected user experience between the two are the same. Detailed drawings for the AndyMark design are posted on the [AndyMark](#) website. All illustrations in the Game Manual show the traditional FIELD design.

3.2.1 GUARDRAIL

The GUARDRAIL is a system that consists of transparent polycarbonate supported on the top and bottom by aluminum extrusion. The GUARDRAIL prevents ROBOTS from inadvertently exiting the FIELD during a MATCH.

There are four (4) gates in the GUARDRAIL that allow access to the FIELD for placement and removal of ROBOTS. The gates are 3 ft. 2 in. (~97 cm) wide and closed and shielded during the MATCH.

Figure 3-3: Gate locations

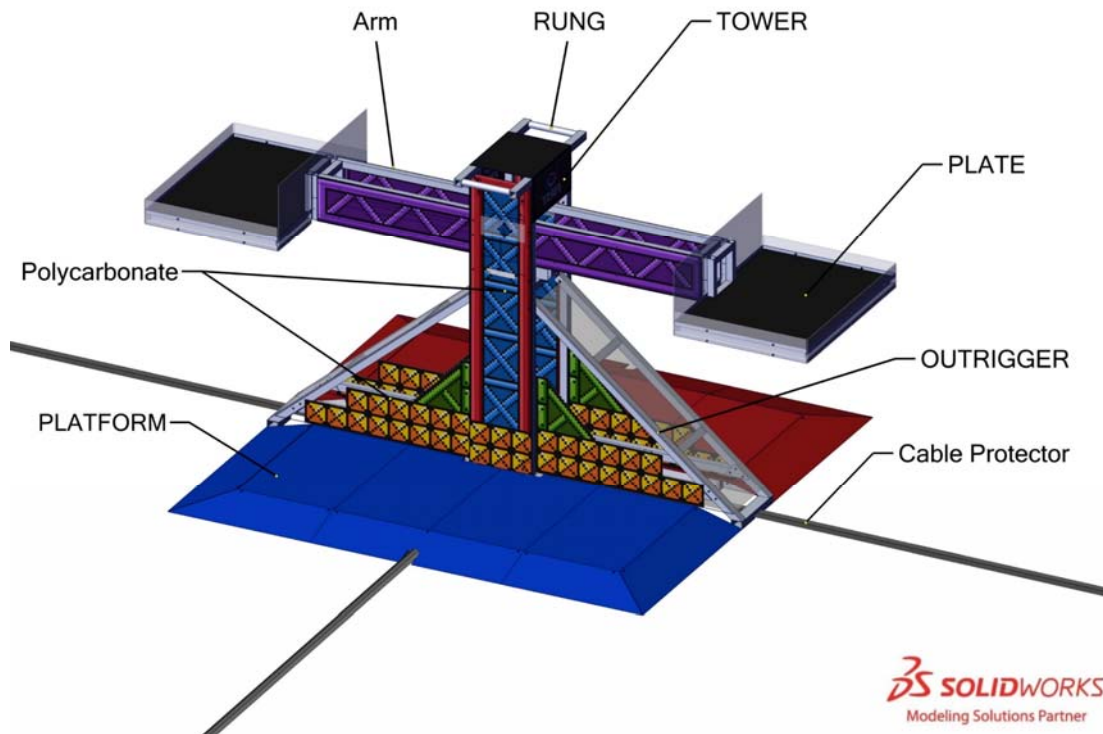


SOLIDWORKS
Modeling Solutions Partner

3.3 SCALE

There is one (1) SCALE centered in the field, and oriented so that the SCALE arm is parallel to the ALLIANCE WALL. The SCALE features an arm, RUNGS, PLATES, OUTRIGGERS, PLATFORMS, and TOWER. All frame surfaces are covered in polycarbonate panels. A cable protector extends from the center of each side of the PLATFORM and is 3 in. (~8 cm) wide and $\frac{3}{4}$ in. (~2 cm) high (Hubbell Inc. FloorTrak3 Floor Cable Cover FT3BK25, Grainger Item # 5D687, black). The cable protector is attached to the field with hook fastener, increasing the height to approximately $\frac{7}{8}$ in. (~2 cm). These cable protectors extend to the GUARDRAILS and the SWITCHES.

Figure 3-4: The SCALE (Note, cable protectors are shown, but are not part of the SCALE)



The BRICKS are graphics depicting golden squares surrounded by a black outline that extends 12 in. (~30cm) above the horizontal surface of the PLATFORM. The BRICKS cover the polycarbonate panels at the base of the TOWER and OUTRIGGERS.

Figure 3-5: The BRICKS



3.3.1 SCALE PLATES

Each SCALE features two (2) PLATES which are 3 ft. (~91 cm) wide and 4 ft. (~122 cm) deep. The outside edges of the two PLATES are 15 ft. (~457 cm) apart. Each PLATE has four polycarbonate walls which contain Philips Color Kinetics LED lights. The wall closest to the center of the FIELD extends 1 ft. 3 in. (~38 cm) above the PLATE surface. The other walls extend up 3 ½ in (~9 cm) above the PLATE surface.

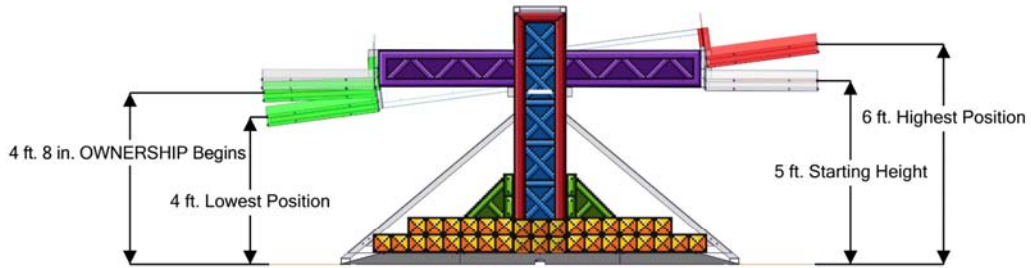
At the start of the MATCH the PLATES are even, such that the outside edges of each PLATE are 5 ft. (~152 cm) +/- 1 in. (~2.5 cm) above the FIELD carpet. The SCALE can tilt and rest in different positions depending on the number and location of the POWER CUBES on the PLATES. During the MATCH, the SCALE is in one of three (3) states based on the magnitude of its tilt:

1. OWNERSHIP by the Red ALLIANCE, or
2. OWNERSHIP by the Blue ALLIANCE, or
3. neither ALLIANCE has OWNERSHIP

If the outside edge of an ALLIANCE colored PLATE is positioned between 4 ft. (~122 cm) and 4 ft. 8 in. (~142 cm) above the FIELD carpet then the ALLIANCE has OWNERSHIP of the SCALE. If the outside edge of an alliance colored PLATE is positioned between 5 ft. 4 in. (~163 cm) and 6 ft. (~182 cm) above the FIELD carpet then the opposing ALLIANCE has OWNERSHIP. When neither ALLIANCE has OWNERSHIP of the SCALE, the outside edges of the PLATES are between 5 ft. 4 in. (~163 cm) and 4 ft. 8 in. (~142 cm) above the FIELD carpet. See Figure 3-6. The time required to move between states is dependent on the weight difference and the distribution of the weight on the SCALE PLATES. Details on OWNERSHIP can be found in [Section 4.2 Scoring](#).



Figure 3-6: SCALE range of motion



Note: It's possible to have the same quantity of POWER CUBES on the PLATES on each side of the SCALE and have the SCALE not be balanced. The location of the POWER CUBES on the SCALE/SWITCH is a factor in its position.

Figure 3-7: SCALE PLATE dimensions

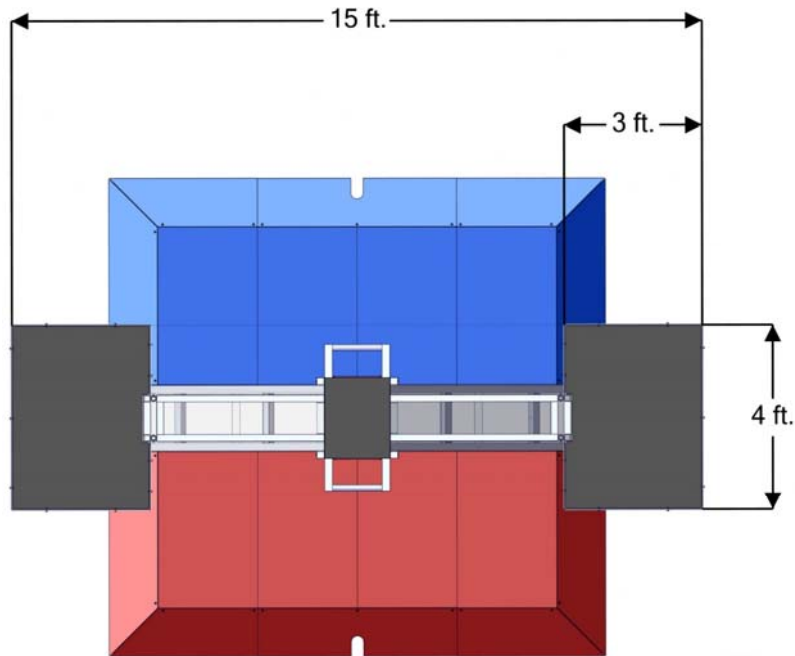
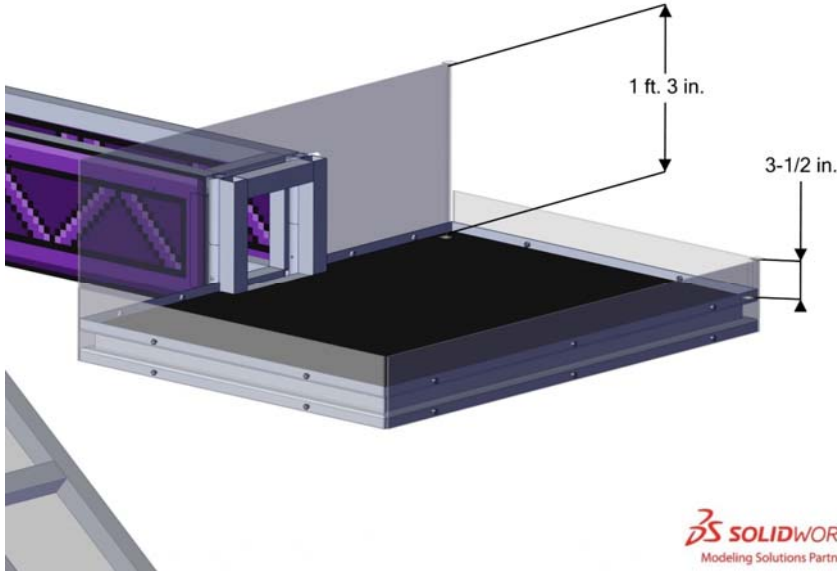




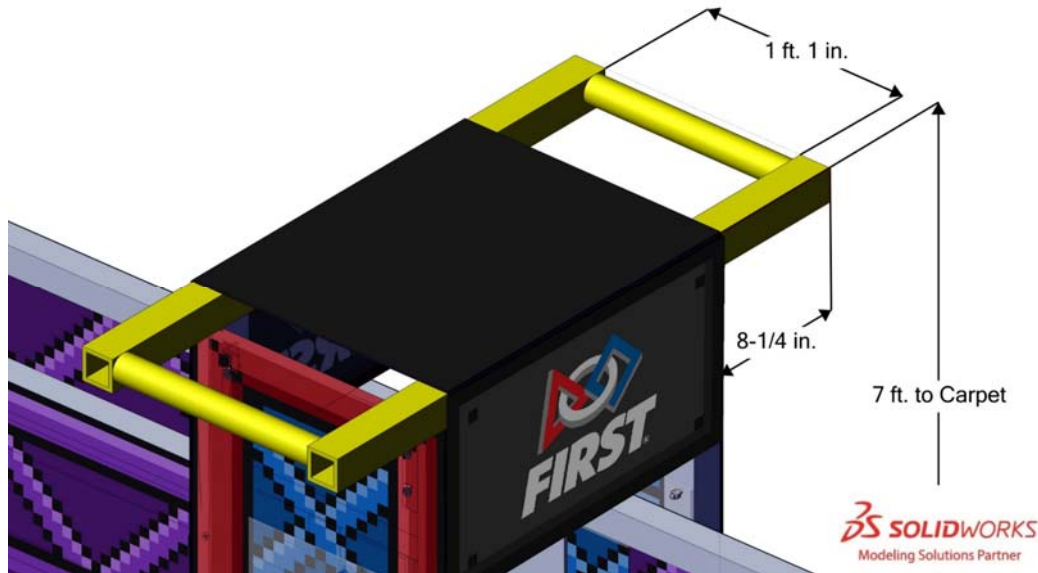
Figure 3-8: SCALE PLATE wall dimensions



3.3.2 RUNGS

At the top of each SCALE there are two RUNGS, one per ALLIANCE. An ALLIANCE'S RUNG extends into their PLATFORM ZONE. RUNGS consist of a 1 ft. 1 in. (~33 cm) long 1 ¼ in. Schedule 40 aluminum pipe supported by 2 in. (~5 cm) box tubing. Each RUNG extends 8 ¼ in. (~21 cm) from the vertical face of the SCALE supports and 7 ft. (~213 cm) from the carpet to the top of the RUNG. The RUNG in Figure 3-9 is highlighted for clarity.

Figure 3-9: RUNGS



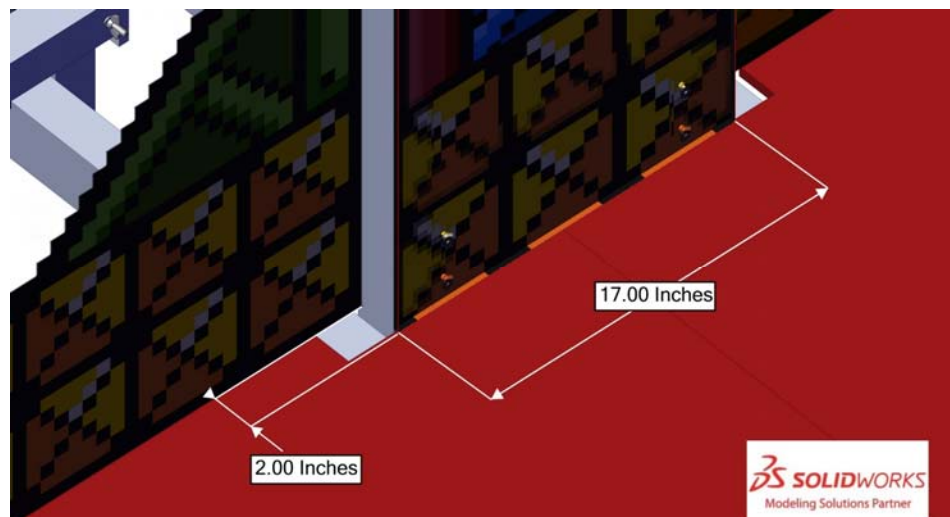
3.3.3 OUTRIGGERS

The OUTRIGGERS are supports for the TOWER constructed from aluminum shielded by polycarbonate

3.3.4 TOWER

The TOWER is the central structure of the SCALE constructed from aluminum shielded by polycarbonate which supports the RUNGS and SCALE PLATES. The tower is 17 in. (~43 cm) wide and extends 2 in. (~5 cm) from the face of the OUTRIGGERS.

Figure 3-10: Tower dimensions



3.3.5 PLATFORM

Located at the base of the SCALE, on each side, is a PLATFORM covered with ALLIANCE colored HDPE. The TOWER and OUTRIGGERS separate one PLATFORM from the other. Each PLATFORM top is 8 ft. 8 in. (~264 cm) wide by 3 ft. 5 ¼ in. (~105 cm) deep and 3 ½ in. (~9 cm) tall. The PLATFORM includes ramps which are 1 ft. 1 in. (~33 cm) long with a 15.35 deg. angle. The ALLIANCE colored tape that abuts the PLATFORM ramps is part of the PLATFORM.

Figure 3-11: PLATFORM top length and width dimensions

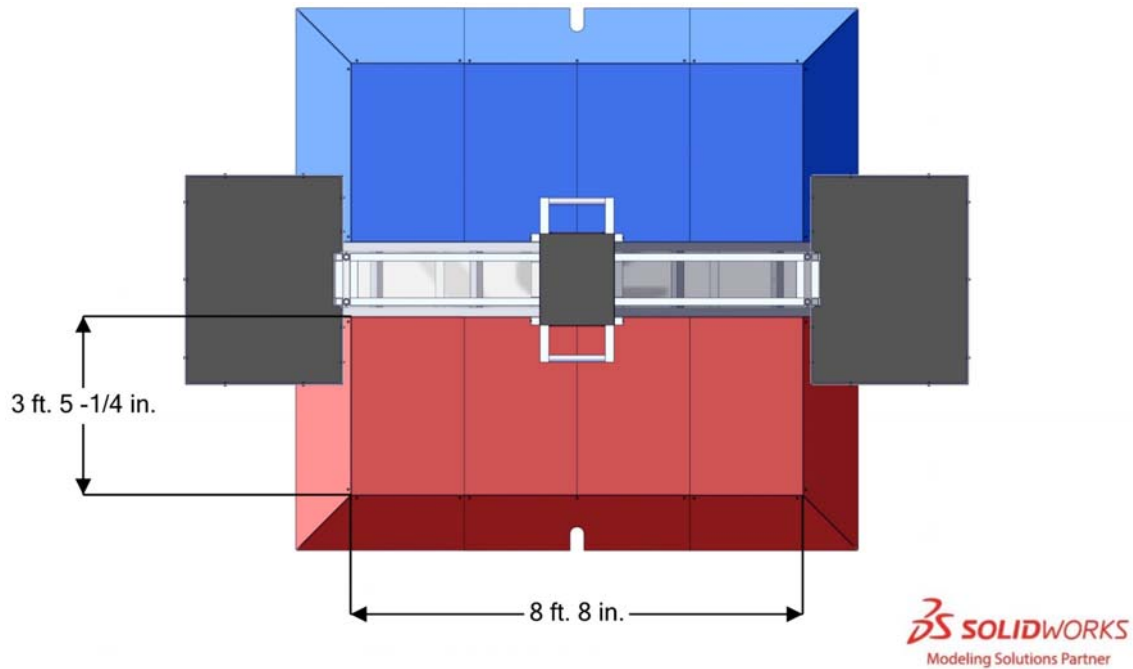
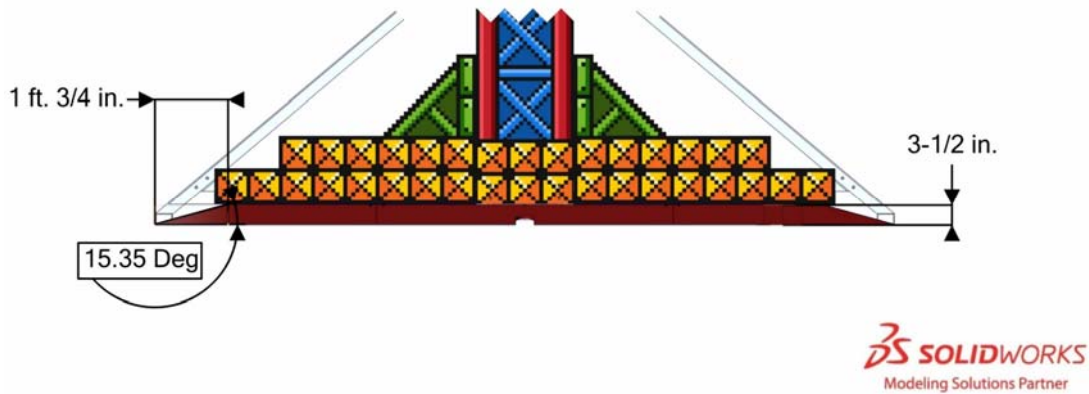


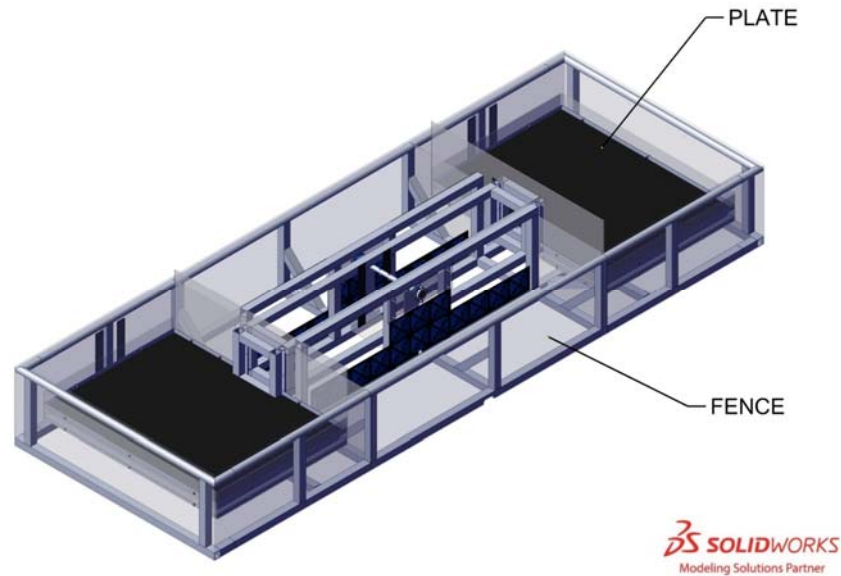
Figure 3-12: PLATFORM height and ramp dimensions



3.4 SWITCH

There are two (2) SWITCHES on the FIELD, one per ALLIANCE. Each SWITCH is centered across the width of the FIELD, with the center of the SWITCH located 14 ft. (~427 cm) from the ALLIANCE STATION. Each SWITCH is surrounded by a [FENCE](#). An ALLIANCE'S SWITCH is the one located closest to its ALLIANCE STATION.

Figure 3-13: SWITCH



3.4.1 SWITCH PLATES

Each SWITCH features two (2) PLATES which are 3 ft. (~91 cm) wide and 4 ft. (~122 cm) deep. The outside edges of the two PLATES are 12 ft. (~366 cm) apart. Each PLATE has four polycarbonate walls which contain Philips Color Kinetics LED lights. The wall closest to the center of the FIELD extends 1 ft. 3 in. (~38 cm) above the PLATE surface. The other walls extend up 3 ½ in (~9 cm) above the PLATE surface

The PLATES are 9 in. (~23 cm) above the carpet when the SWITCH is level. Like the SCALE, the SWITCH tilts and rests in different positions based on the placement of POWER CUBES. During the MATCH, the SWITCH is in one of two (2) states based on the magnitude of its tilt:

1. OWNERSHIP by its ALLIANCE, or
2. neither ALLIANCE has OWNERSHIP

If the outside edge of an ALLIANCE'S colored PLATE is positioned between 3 in. (~8 cm) and 6 in. (~15 cm) above the FIELD carpet then the ALLIANCE has OWNERSHIP of its SWITCH. If the outside edge of an ALLIANCE colored PLATE is positioned between 6 in (~15 cm) and 15 in. (~38 cm) above the FIELD carpet then neither ALLIANCE has OWNERSHIP of the SWITCH. See Figure 3-15. The time required to move between states is dependent on the weight difference and the distribution of the weight on the SWITCH PLATES. Details on OWNERSHIP can be found in [Section 4.2_Scoring](#).



Figure 3-14: SWITCH PLATE dimensions

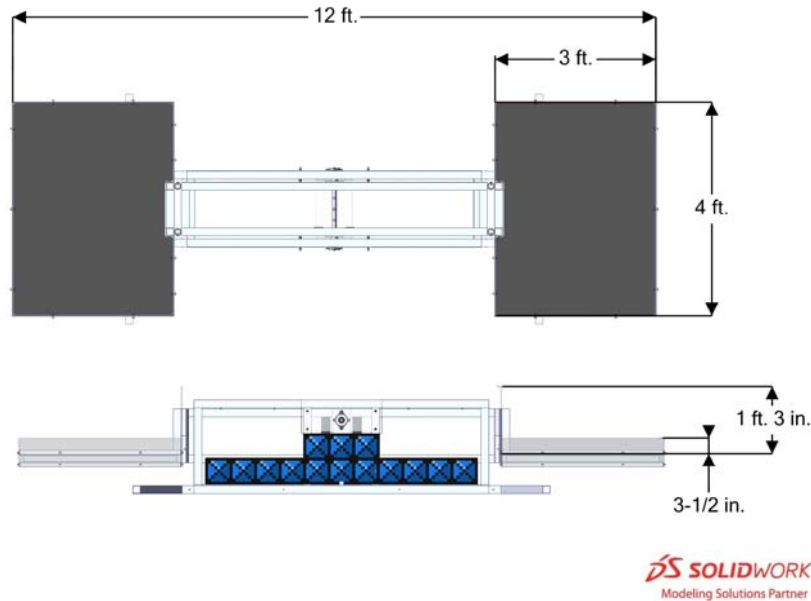
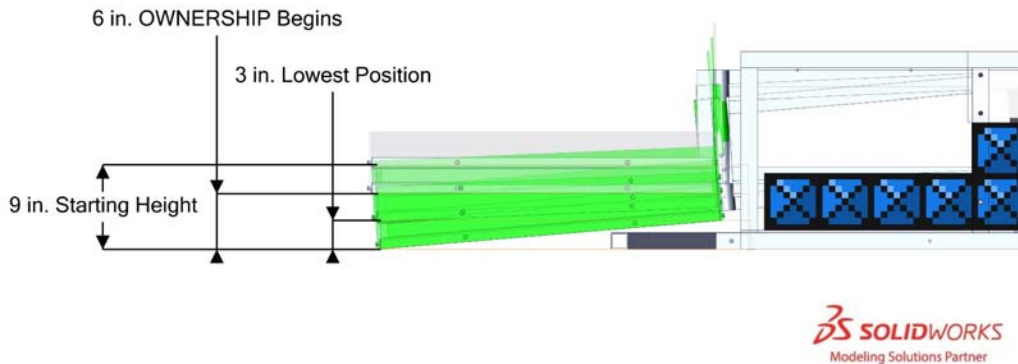


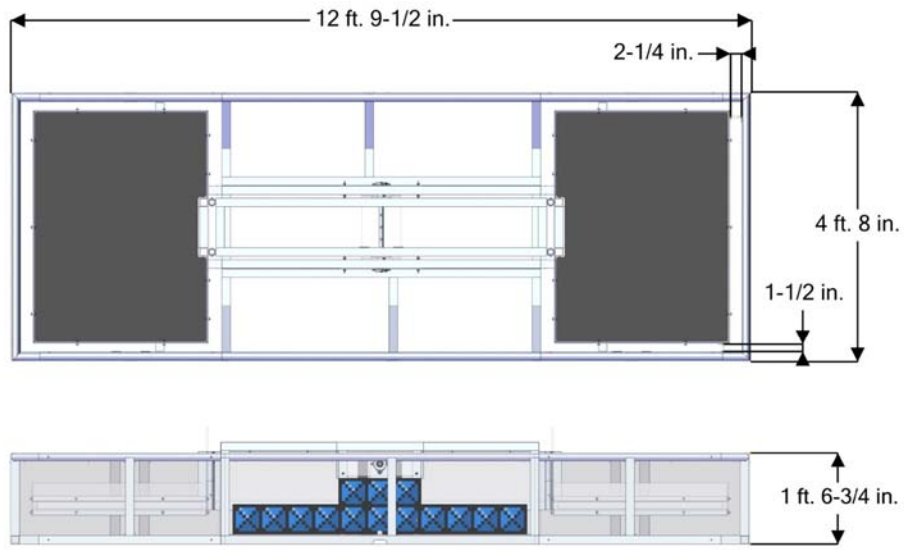
Figure 3-15: SWITCH range of motion



3.4.2 FENCE

Each SWITCH is surrounded by a FENCE constructed from aluminum shielded by polycarbonate. The FENCE is 12 ft. 9 ½ in. (~390 cm) wide by 4 ft. 8 in. (~142 cm) deep by 1 ft. 6 ¾ in. (~48 cm) tall. The gap between the FENCE and the sides of the PLATES is approximately 1 ½ in. (~4 cm). When the SWITCH is level, the gap between the FENCE and the outer edges of the PLATES is approximately 2 ¼ in (~8 cm).

Figure 3-16: FENCE

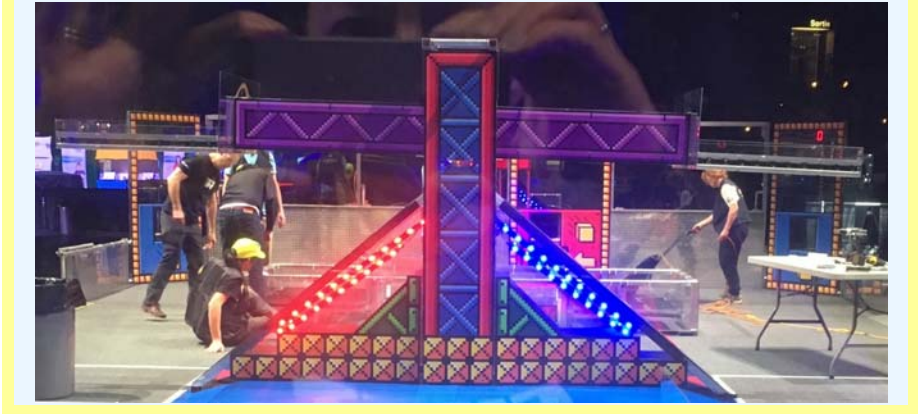


3.5 PLATE Lighting

Each PLATE is highlighted by Philips Color Kinetics Flex LED light strings.

Until further notice, events are instructed to install the SCALE light strings in the cavity below the outriggers instead of around the PLATES, approximately as shown below.

Figure 3-17 Temporary SCALE lighting.



These lights indicate ALLIANCE color and OWNERSHIP. The lights have the following states:



Table 3-1: PLATE Lighting

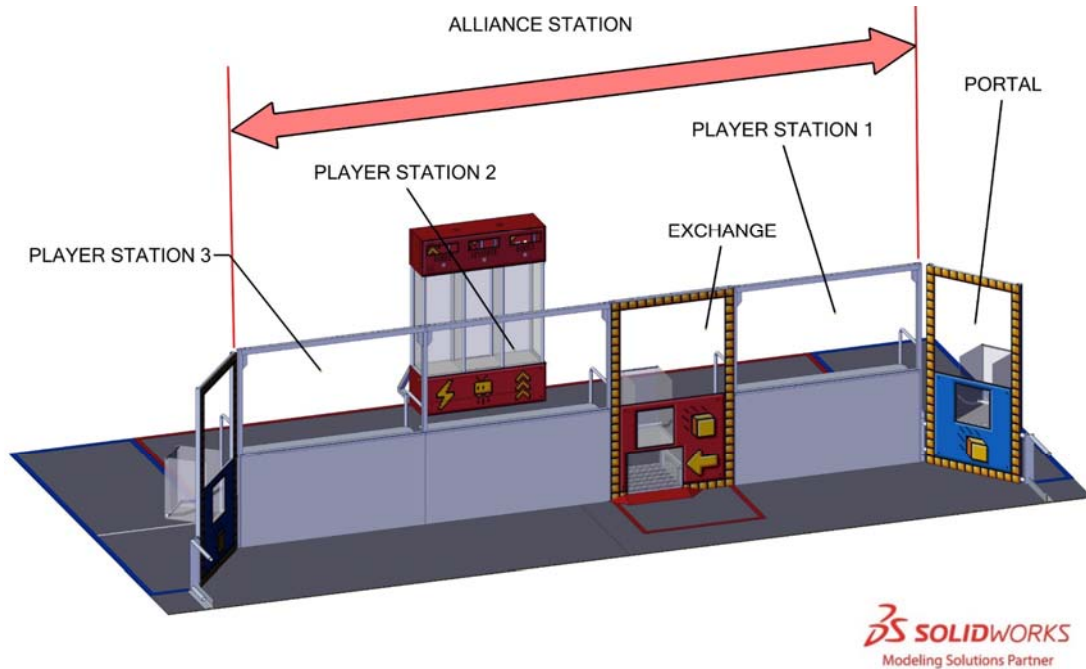
Color	Pre-MATCH	AUTO	TELEOP	Post-MATCH
Blue at 100% brightness			ALLIANCE color	
Blue (pulsing)			Blue OWNERSHIP	
Blue (pulsing) with solid red corners		N/A	Blue FORCE POWER UP is active	
Blue at 25% brightness			Red OWNERSHIP	
Blue (chase pattern)		N/A	Blue BOOST POWER UP is active	
Red at 100% brightness			ALLIANCE color	N/A
Red (pulsing)	N/A		Red OWNERSHIP	
Red (pulsing) with solid blue corners		N/A	Red FORCE POWER UP is active	
Red at 25% brightness			Blue OWNERSHIP	
Red (chase pattern)		N/A	Red BOOST POWER UP is active	
Purple (pulsing)				FIELD is safe for FIELD STAFF
Green			N/A	FIELD is safe for all
OFF	MATCH ready to start			N/A

ALLIANCE color of the PLATES is provided to the Driver Station software by the Field Management System. More details are in [Section 3.10 The Field Management System](#)

3.6 ALLIANCE WALL

The ALLIANCE WALL is the structure that separates ROBOTS from DRIVE TEAMS (except the TECHNICIAN) and consists of three (3) PLAYER STATIONS, and an EXCHANGE wall.

Figure 3-18: ALLIANCE STATION



3.6.1 PLAYER STATION

A PLAYER STATION is one (1) of three (3) assigned positions in an ALLIANCE WALL from where a DRIVE TEAM operates their ROBOT. Each PLAYER STATION is made from a 3 ft. (~91 cm) tall diamond plate panel base topped with a 3 ft. 6 in. (~107 cm) tall transparent plastic panel. An aluminum shelf is attached to each PLAYER STATION to support the DRIVE TEAM'S OPERATOR CONSOLE. The shelf is 5 ft. 9 in. (~175 cm) wide and 1 ft. (~30 cm) deep. There is a 4 ft. 6 in. (~137 cm) long by 2 in. (nominal) wide strip of hook-and-loop tape ("loop" side) along the center of the support shelf that may be used to secure the OPERATOR CONSOLE to the shelf.

Each PLAYER STATION contains the following components for Teams:

- One Ethernet Cable: attaches to the Ethernet port of the OPERATOR CONSOLE and provides connectivity to the FIELD Management System.
- One 120VAC NEMA 5-15R power outlet: located on each PLAYER STATION shelf and protected by its own 2-Amp circuit breaker. It can be used to power the OPERATOR CONSOLE. DRIVE TEAMS are responsible for monitoring their power consumption as a tripped breaker in the outlet does not constitute an ARCADE fault.
- One Emergency Stop (E-Stop) button: located on the left side of the PLAYER STATION shelf and should be used to deactivate a ROBOT in an emergency.
- One Team sign: displays the Team number and located at the top of each PLAYER STATION.
- One Team LED: indicates ALLIANCE color, ROBOT status, and E-Stop status and centered at the top of each PLAYER STATION. Team LED states include:
 - Solid: indicates that the ROBOT is connected and enabled. This will only happen during a MATCH.

- Blinking: indicates that either the Field Management System is preset for the MATCH or it's during a MATCH and the corresponding ROBOT has lost connectivity.
- Off: indicates that the MATCH has not started yet, but the ROBOT is linked and disabled. – If the amber LED is on, the E-stop button has been pressed.
- One Timer (in the PORTAL adjacent to PLAYER STATION 1): displays the official time remaining in AUTO, TELEOP, and TIMEOUTS and marked with white tape along the bottom edge.
- Field Management System hardware and wiring: mostly located below the center PLAYER STATION shelf.

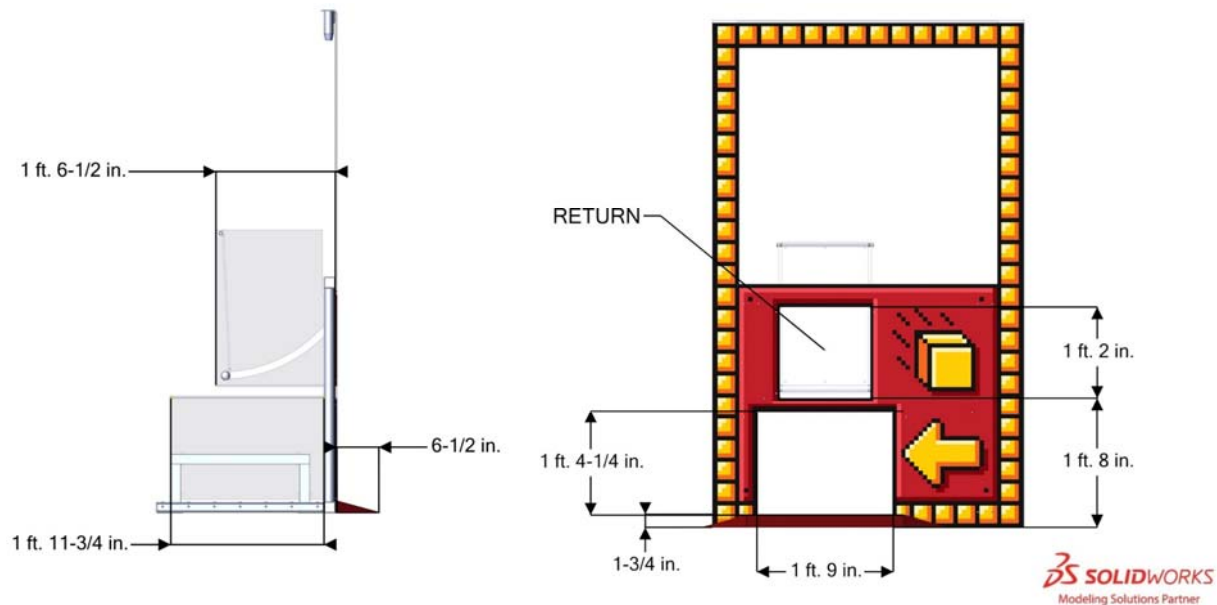
3.6.2 EXCHANGE

An EXCHANGE is a polycarbonate wall 6 ft. 5 ¾ in. (~197 cm) tall by 4 ft. (~122 cm) wide located between PLAYER STATION 1 and PLAYER STATION 2 and used by ROBOTS to deliver POWER CUBES to HUMAN PLAYERS. HUMAN PLAYERS can then either place POWER CUBES in the VAULT or feed them back to the ROBOT through the RETURN.

Each EXCHANGE has a lower opening 1 ft. 4 ¼ in. (~41 cm) tall and is 1 ft. 9 in. (~53 cm) wide used to deliver POWER CUBES to the HUMAN PLAYER. A small ramp, 1 ¾ in. (~4 cm) tall by 6 ½ in. (~17 cm) deep, leads to a series of conveyor rollers. The conveyor rollers are spun by the HUMAN PLAYER to move the POWER CUBE through a polycarbonate tunnel that is 1 ft. 11 ¾ in. (~60 cm) deep.

Each EXCHANGE also features a RETURN used to deliver POWER CUBES to ROBOTS. The RETURN opening is a 1ft. 2 in. (~36 cm) square, centered above the lower opening and is located 1 ft. 8 in. (~51 cm) above the carpet. Behind the RETURN opening is a 1 ft. 6 ½ in. (~47 cm) deep polycarbonate chute. The chute features a swinging wall designed to push the POWER CUBE onto the FIELD.

Figure 3-19: EXCHANGE



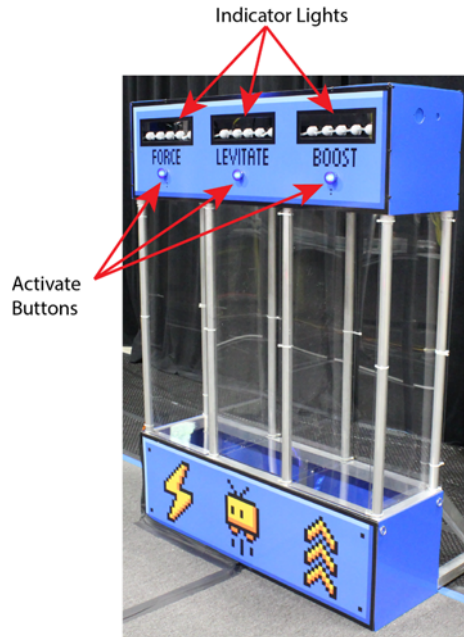
3.6.3 VAULT

The VAULT is an aluminum and plastic structure used by HUMAN PLAYERS to turn POWER CUBES in to POWER UPS. There are three (3) columns within the VAULT. Each column is 1 ft. 1-1/2 in. (~34 cm) wide by 3 ft. 3-1/4 in. (~100 cm) tall with the bottom located 1 ft. 3-1/2 in. (~39 cm) above the carpet. Each of the three (3) columns in the VAULT correspond to a POWER UP. When standing in the

ALLIANCE STATION and facing the open columns of the VAULT the column to the left is the FORCE POWER UP, the center column is the LEVITATE POWER UP and the column on the right is the BOOST POWER UP.

POWER CUBES placed logo-side-up may result in POWER CUBES not being sensed consistently by the FIELD.

Figure 3-20: Blue ALLIANCE VAULT











Caution, there may be orientations where all three (3) POWER CUBES will not fit in a VAULT column, but if HUMAN PLAYERS place POWER CUBES logo side down they'll fit with room to spare.



3.6.3.1 VAULT lighting

Lights at the top of each VAULT column display the POWER CUBE count for that column. The lights have the following states:

Table 3-2: VAULT Lighting

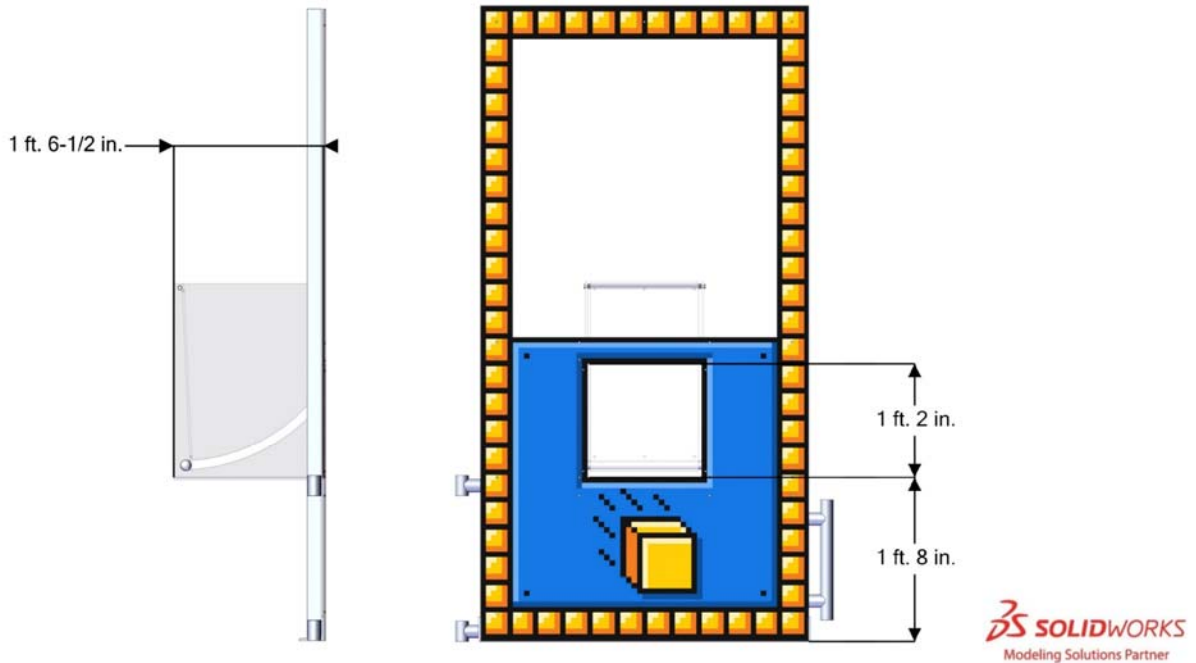
Color	Meaning
	No POWER CUBES in column
	One (1) POWER CUBE in column
	Two (2) POWER CUBES in column
	Three (3) POWER CUBES in column
	Blue POWER UP in queue
	Blue POWER UP played
	Red POWER UP in queue
	Red POWER UP played

The lights illuminate one bulb per POWER CUBE and show one (1), two (2), three (3) or none (0) by lighting up from left to right. To play a POWER UP, the button corresponding to the column and associated POWER UP is pressed by the HUMAN PLAYER. Once played, all five (5) lights in the corresponding column are illuminated in the ALLIANCE color. If an ALLIANCE plays a POWER UP during the time when an opposing ALLIANCE's POWER UP is active, the POWER UP is queued, indicated by five (5) pulsing lights. See [Section 4.3 POWER UPS](#) for more details.

3.7 PORTAL

HUMAN PLAYERS may deliver POWER CUBES to ROBOTS through either of the PORTAL walls. Each PORTAL wall features a 1 ft. 2 in. (~36 cm) square opening, centered across the width of the panel and located 1 ft. 8 in. (~51 cm) from the carpet. Behind the opening is a 1 ft. 6 ½ in. (~47 cm) polycarbonate chute. The chute features a swinging wall that the HUMAN PLAYER uses to push the POWER CUBE onto the FIELD.

Figure 3-21: PORTAL



3.8 POWER CUBE

POWER CUBES are used to affect the position of the SCALE and SWITCH PLATES, and can be traded in for POWER UPS. A POWER CUBE is a 1 ft. 1 in. (~33 cm) wide by 1 ft. 1 in. (~33 cm) deep by 11 in. (~27 cm) tall HDPE milk crate covered in a yellow nylon (600 Denier) cover. The *FIRST*[®] logo covers the open face of the milk crate. Each POWER CUBE weighs approximately 3 ¼ lbs (~1.5 kg). POWER CUBES may be purchased from AndyMark (am-3818 and am-3741), Innovation First (217-6188 and 217-6193), and Rev Robotics (REV-21-1217 and REV-21-1218). Please note that due to the use of recycled material in the manufacturing process, the batches of crates will vary slightly in color, but not such that it's perceptible with the cover in place.

Figure 3-22: POWER CUBE

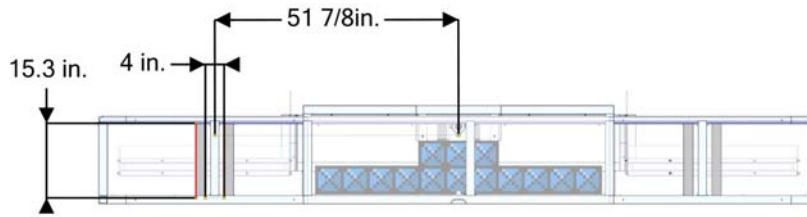


3.9 Vision Targets

Vision targets are located on the SWITCH FENCE facing the ALLIANCE WALL using 2 in. (~5 cm) strips of [3M 8830 Scotchlite Reflective Material](#) and are used to highlight the locations of the PLATES on the SWITCH.

Each vision target consists of two vertical, 16 in. (~41 cm) tall strips of reflective material, with a 4 in. (~10 cm) gap between them. Elements of the SWITCH obscure the top and bottom of the target, resulting in approximately 15.3 in. (~39 cm) of viewable height when viewed straight on. The center of each target is located 51 7/8" in. (~132 cm) from the center of the SWITCH.

Figure 3-23: Vision Target Locations



3.10 The FIELD Management System

The FIELD Management System (FMS) is the electronics core responsible for controlling the *FIRST* Robotics Competition playing field. The FMS encompasses all field electronics, including the computers, REFEREE touchscreens, wireless access point, sensors, stack lights, E-Stops, etc.

When a DRIVE TEAM connects the Ethernet cable from their assigned PLAYER STATION to their OPERATOR CONSOLE, the Driver Station software on the OPERATOR CONSOLE computer will begin to communicate with the Field Management System (FMS). Once connected to FMS, the only open ports available are described in Table 3-3.

Table 3-3: Open FMS Ports

Port	Designation	Bi-directional?
UDP/TCP 1180-1190	Camera data from the roboRIO to the Driver Station (DS) when the camera is connected the roboRIO via USB	Yes
TCP 1735	SmartDashboard	Yes
UDP 1130	Dashboard-to-ROBOT control data	Yes
UDP 1140	ROBOT-to-Dashboard status data	Yes
HTTP 80	Camera connected via switch on the ROBOT	Yes
HTTP 443	Camera connected via switch on the ROBOT	Yes
UDP/TCP 554	Real-Time Streaming Protocol for h.264 camera streaming	Yes
UDP/TCP 5800-5810	Team Use	Yes

Teams may use these ports as they wish if they do not employ them as outlined above (e.g. TCP 1180 can be used to pass data back and forth between the ROBOT and the Driver Station software if the Team chooses not to use the camera on USB). Note that ROBOT code cannot be deployed while connected to the FMS. Additional information about the FMS may be found in the [FMS Whitepaper](#).

The FMS provides the ALLIANCE color assigned to each PLATE to the Driver Station software. Immediately following the assignment of PLATE color prior to the start of AUTO. Specific details on the format of the data can be found on the [2018 FRC Control System website](#).

While FMS does provide the ALLIANCE PLATE color to each team's Driver Station, teams must write the necessary ROBOT code to make use of the information during a MATCH.



FMS alerts participants to milestones in the MATCH using audio cues. Please note that audio cues are intended to be a courtesy to participants and not intended as official MATCH markers. If there is a discrepancy between an audio cue and the FIELD timers, the FIELD timers are the authority.

- MATCH Start & PLATES randomized: "Startup Sound"
- AUTO Start: "Cavalry Charge"
- T=0 for AUTO: Buzzer
- Start of TELEOP: Three (3) Bells
- T-30 seconds in TELEOP: Train Whistle
- T=0 for TELEOP/MATCH end: Buzzer
- MATCH stopped: Foghorn
- POWER UP activated: "Linear Popping"



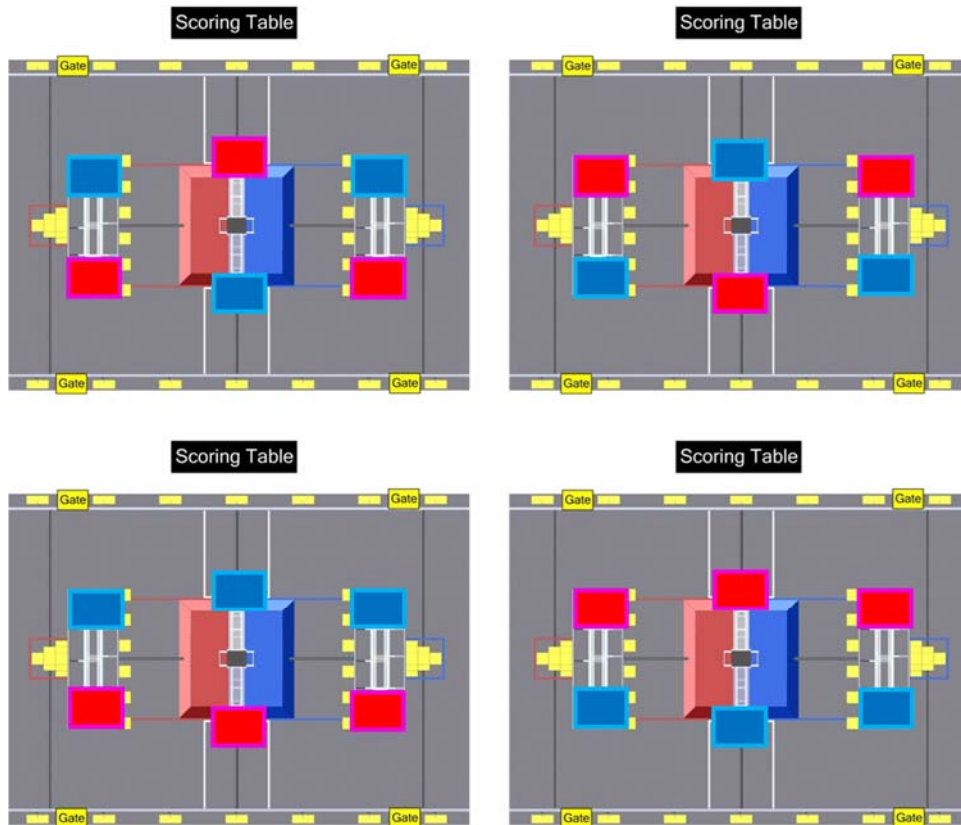
4 MATCH Play

During each *FIRST*[®] POWER UPSM MATCH, two ALLIANCES (cooperatives of up to four (4) *FIRST*[®] Robotics Competition Teams) play out a multiplayer video game to defeat the boss by gaining OWNERSHIP of a SCALE and SWITCHES by tipping them in their favor or by using POWER UPS.

4.1.1 Stages

Each MATCH is divided into two stages. The first stage, called Autonomous (AUTO), is the first fifteen (0:15) seconds of a MATCH in which ROBOTS operate without any DRIVE TEAM control or input. Prior to the start of AUTO, the assignments of ALLIANCE colors for SWITCH and SCALE PLATES are randomized among the four states in Figure 4-1 and transmitted to the OPERATOR CONSOLE by the Field Management System (FMS). During AUTO, ROBOTS attempt to deliver preloaded POWER CUBES to PLATES, retrieve additional POWER CUBES from around the FIELD, and cross their AUTO LINE any time before the end of the stage.

Figure 4-1 Possible PLATE assignments



 **SOLIDWORKS**
Modeling Solutions Partner

Teleoperated (TELEOP) is the second stage in a MATCH and is two minutes and fifteen seconds (2:15) long. During this stage, DRIVERS remotely operate ROBOTS to retrieve and place POWER CUBES on the PLATES and feed POWER CUBES through the EXCHANGE for placement in the VAULT to earn

POWER UPS. The final thirty (30) seconds of the TELEOP stage is considered the ENDGAME, during which ROBOTS prepare to FACE THE BOSS.

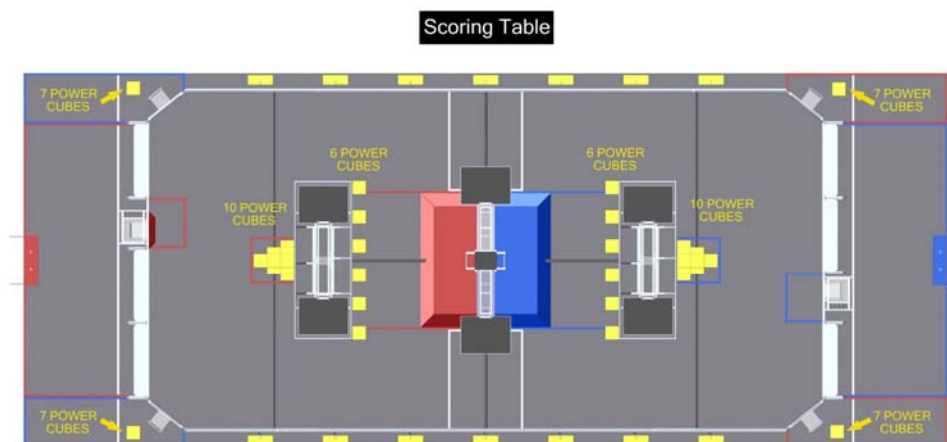
In addition to the two (2) minutes and thirty (30) seconds of game play, each MATCH also has pre- and post-MATCH time for setup and reset of the ARCADE. During ARCADE reset, the ARCADE is cleared of ROBOTS and OPERATOR CONSOLES from the MATCH that just ended. The ROBOTS and OPERATOR CONSOLES for the subsequent MATCH are loaded into the ARCADE by DRIVE TEAMS at this time. FIELD STAFF also use this time to reset ARCADE elements and POWER CUBES.

4.1.2 MATCH Setup

Prior to the start of each MATCH, POWER CUBES, elements used to affect the position of the SCALE and SWITCHES and earn POWER UPS, are staged as shown in Figure 4-2. Staging details are as follows:

- A. Seven (7) in each PORTAL (on the carpet between the PORTAL wall and the STARTING LINE), minus any preloaded POWER CUBES,
- B. Six (6) next to each SWITCH. They are arranged approximately equidistant from each other along the face of the FENCE closest to the SCALE, *FIRST* logo facing up
- C. Ten (10) located in each ALLIANCE POWER CUBE PILE (in a pyramid formation, with six on the bottom, three in the middle, and one on top, justified toward the SWITCH, *FIRST* logo facing up)

Figure 4-2: POWER CUBE staging



SOLIDWORKS
Modeling Solutions Partner

When a DRIVE TEAM loads their ROBOT onto the FIELD for a MATCH they may elect to preload up to one (1) POWER CUBE in or on their ROBOT such that it is fully and only supported by the ROBOT. A minimum of five (5) POWER CUBES must remain in each of their two (2) PORTALS after any preloads.

If order placement of ROBOTS matters to either or both ALLIANCES, the ALLIANCE must notify the Head REFEREE during setup for that MATCH. Upon notification, the Head REFEREE will require ALLIANCES alternate placement of all ROBOTS. In a Qualification MATCH, ROBOTS will be placed in the following order: Red Station 1 ROBOT, Blue Station 1 ROBOT, Red Station 2 ROBOT, Blue Station 2 ROBOT, Red Station 3 ROBOT, Blue Station 3 ROBOT. In a PLAYOFF MATCH, the same pattern is applied, but instead of Red ALLIANCE placing, the higher seeded ALLIANCE (regardless of color) will place last.

4.2 Scoring

ALLIANCES are rewarded for accomplishing various actions throughout the course of a MATCH, including autonomous movement, having OWNERSHIP of their SWITCH or the SCALE, CLIMBING to FACE THE BOSS, and winning or tying MATCHES. Rewards are granted either via MATCH points (which contribute to the ALLIANCE'S MATCH score) or Ranking Points (which increase the measure used to rank teams in the Qualification tournament). Such actions, their criteria for completion, and their point values are listed in Table 4-1. Scores are assessed and updated throughout the MATCH.

The primary method of earning points in *FIRST*[®] POWER UPSM is by placing POWER CUBES on the PLATES of the SWITCH or SCALE to establish OWNERSHIP. OWNERSHIP is a state of the ALLIANCE'S SWITCH or SCALE where it is tilted in favor of an ALLIANCE colored PLATE, such that the outside edge of the ALLIANCE colored PLATE is at or less than a specified height above the carpet. ALLIANCES earn points when OWNERSHIP is established and additional points for each additional second of OWNERSHIP.

The SWITCH located closest to its ALLIANCE STATION is considered that ALLIANCE'S SWITCH. While any ROBOT can place POWER CUBES on the PLATES of either SWITCH, an ALLIANCE can only have OWNERSHIP of, and accumulate points for, their SWITCH.

An ALLIANCE has OWNERSHIP of their SWITCH when:

- A. the SWITCH is tilted in favor of their ALLIANCE colored PLATE, such that the outside edge of the ALLIANCE colored PLATE is at or less than 6 in. (~15 cm) from the floor for at least one (1) second, or
- B. they have played the FORCE POWER UP at level 1 or 3 (see Section 4.3 POWER UPS)

The Blue ALLIANCE'S SWITCH accumulates points for the Blue ALLIANCE when the PLATE illuminated and pulsing with blue lights is down.

The SWITCH does not accumulate points for either ALLIANCE when the blue PLATE is above 6 in (~15 cm).

An ALLIANCE has OWNERSHIP of the SCALE when:

- A. the SCALE is tilted in favor of their ALLIANCE colored PLATE, such that the outside edge of the ALLIANCE'S colored PLATE is at or lower than 4 ft. 8 in. (~142 cm) from the floor for at least one (1) second and there isn't an active opponent's Level 2 or 3 FORCE, or
- B. they have played the FORCE POWER UP at level 2 or 3 (see [Section 4.3 POWER UPS](#))

Note that points for the SWITCH and SCALE are accrued over time and not a direct function of the number of POWER CUBES placed on the SWITCH or SCALE.

Points are not taken away when OWNERSHIP changes, but rather stop accumulating (if balanced) or start accumulating for the opposite ALLIANCE if they take OWNERSHIP of the SCALE.

ROBOTS deliver POWER CUBES to HUMAN PLAYERS through the EXCHANGE. Once a POWER CUBE is delivered through the EXCHANGE, HUMAN PLAYERS may:

1. place the POWER CUBE into the VAULT for points and application toward a POWER UP, or

2. return the POWER CUBE to the FIELD using the RETURN in the EXCHANGE wall, or
3. keep the POWER CUBE inside the ALLIANCE STATION (effectively delaying the selection until a later time or not using it all.)

An ALLIANCE can earn up to four (4) Ranking Points (RP) per Qualification MATCH, as described in Table 4-1. There are no RP, or comparable point bonuses, in Playoff MATCHES.

Table 4-1: FIRST® POWER UPSM rewards

Action	Criteria	MATCH Points		Ranking Points
		AUTO	TELEOP	
AUTO-RUN	For each ROBOT that breaks the vertical plane of the AUTO LINE with its BUMPER at any point in the AUTO stage	5	-	-
OWNERSHIP	SCALE	2 + 2/sec	1 + 1/sec	-
	ALLIANCE'S SWITCH	2 + 2/sec	1 + 1/sec	-
VAULT	For each POWER CUBE placed in the VAULT	-	5	-
PARKING	For each ROBOT fully supported by the SCALE (either directly or transitively), not at all in the opponent's PLATFORM ZONE, and has not CLIMBED	-	5	-
CLIMBING	For each ROBOT fully supported by the SCALE (either directly or transitively) with BUMPERS fully above the BRICKS at T=0, not in direct contact with their PLATFORM, and not at all in the opponent's PLATFORM ZONE	-	30	-
FACE THE BOSS	All three (3) ALLIANCE ROBOTS have CLIMBED or two (2) ROBOTS have CLIMBED and the ALLIANCE has played the LEVITATE POWER UP	-	-	1
AUTO QUEST	ALLIANCE completes three (3) AUTO-RUNS and has OWNERSHIP of their SWITCH at T=0 of the AUTO stage	-	-	1
Win	ALLIANCE's final MATCH score exceeds their opponents'	-	-	2
Tie	ALLIANCE's final MATCH score equals their opponents'	-	-	1

Points are earned for establishing OWNERSHIP, with additional points earned for each additional second of OWNERSHIP. For example, a team that establishes OWNERSHIP of their SWITCH three (3) seconds after the start of AUTO and maintains OWNERSHIP for five (5) seconds earns two (2) points + ten (10) points, for a total of twelve (12) points.

The MATCH points listed in Table 4-1 for OWNERSHIP during the TELEOP stage are increased if the BOOST POWER UP is played. See [Section 4.3](#) for details on BOOST.

AUTO-RUN and CLIMBING are both evaluated and scored by human REFEREES. Teams are encouraged to make these actions obvious and unambiguous.

4.3 POWER UPS

POWER UPS are advantages an ALLIANCE can earn and play throughout the TELEOP stage of the MATCH. ALLIANCES earn POWER UPS by delivering POWER CUBES through their EXCHANGE to their HUMAN PLAYERS who place them into their VAULT. Table 4-2 lists the POWER UPS, their cost, and the effect when it is played by an ALLIANCE.

Table 4-2: POWER UPS

Name	# of POWER CUBES	Effect	Duration (seconds)
LEVITATE	3	An additional CLIMBING ROBOT, up to a maximum of three (3) ROBOTS, is credited to the ALLIANCE at the end of the MATCH	N/A
FORCE	1	ALLIANCE earns OWNERSHIP points from their SWITCH regardless of PLATE position	10
	2	ALLIANCE earns OWNERSHIP points from the SCALE regardless of PLATE position	10
	3	ALLIANCE earns OWNERSHIP points from the SWITCH and the SCALE regardless of PLATE position	10
BOOST	1	Doubles the points being earned by the ALLIANCE for OWNERSHIP of their SWITCH.	10
	2	Doubles the points being earned by the ALLIANCE for OWNERSHIP of the SCALE.	10
	3	Doubles the points earned by the ALLIANCE for OWNERSHIP of a) their SWITCH and b) the SCALE.	10

If LEVITATE is played the CLIMB is credited randomly to any ROBOT on the ALLIANCE who is not PARKING or CLIMBING at the end of the MATCH. If all ROBOTS on the ALLIANCE are either PARKING or CLIMBING, one randomly chosen PARKING ROBOT will be upgraded from PARKING to CLIMBING.

An ALLIANCE plays a POWER UP by pressing the corresponding button on the VAULT. Only one (1) instance of the FORCE or BOOST POWER UP can be active at a time. If an ALLIANCE pushes the button for FORCE/BOOST while their other FORCE/BOOST is active, the button press is ignored. The LEVITATE POWER UP can be played at any time during the TELEOP stage.

A POWER UP is active for the duration listed in Table 4-2. If an ALLIANCE plays BOOST or FORCE during the time when an opposing ALLIANCE's POWER UP is active, the POWER UP is queued and becomes active immediately upon the conclusion of the currently active POWER UP. Once a POWER UP is played, it cannot be cancelled.

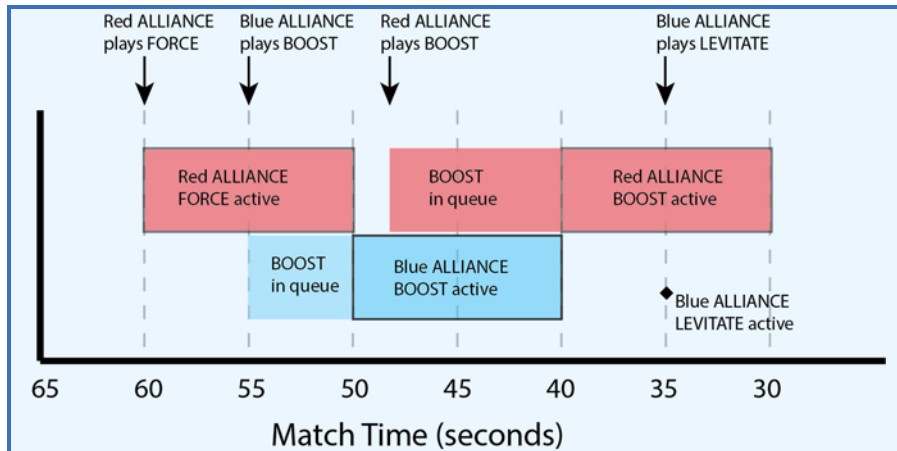


Figure 4-3: POWER UP timeline example

Example: the Red ALLIANCE plays FORCE with sixty (60) seconds remaining in the MATCH. FORCE is in-progress from sixty (60) seconds to fifty (50) seconds, during which time no additional instances of FORCE or BOOST can be active.

The Blue ALLIANCE plays BOOST with fifty-five (55) seconds remaining in the MATCH, but it does not become active until the Red ALLIANCE FORCE ends at fifty (50) seconds.

The Red ALLIANCE plays BOOST with forty-eight (48) seconds remaining in the MATCH, but it does not become active until the Blue ALLIANCE BOOST ends at forty (40) seconds.

The Blue ALLIANCE plays LEVITATE with thirty-five (35) seconds remaining in the MATCH. It is immediately active for the Blue ALLIANCE and added to their score.

FORCE and BOOST can be played with as few as one (1) or as many as three (3) POWER CUBES in their corresponding column of the VAULT. However, an ALLIANCE may only play each POWER UP one time in the MATCH. Additional POWER CUBES placed into the FORCE or BOOST columns after the activation of the corresponding POWER UP do earn points for the ALLIANCE.

Example: the RED ALLIANCE places two (2) POWER CUBES in the FORCE column of their VAULT. With ninety (90) seconds remaining in the MATCH, a HUMAN PLAYER plays FORCE on the SCALE. The Red ALLIANCE has now played their FORCE, and cannot play another FORCE during the MATCH. Additional POWER CUBES placed into the FORCE column will earn points for the Red ALLIANCE, per Table 4-1.

4.4 Rule Violations

Upon a rule violation, one or more of the penalties listed in Table 4-3 will be assessed.

Table 4-3: Penalty Table

Action	Penalty
FOUL	5 points credited towards the opponent's total score.
TECH FOUL	25 points credited towards the opponent's total score.
YELLOW CARD	a warning issued by the Head REFEREE for egregious ROBOT or Team member behavior or rule violations. A subsequent YELLOW CARD within the same tournament phase will lead to a RED CARD.
RED CARD	a penalty assessed for egregious ROBOT or Team member behavior, or rule violations, which results in a Team being DISQUALIFIED for the MATCH.
DISABLED	ROBOT will be commanded to deactivate all outputs, rendering the ROBOT inoperable for the remainder of the MATCH.
DISQUALIFIED	the state of a Team in which they receive zero (0) MATCH points in a qualification MATCH or causes their ALLIANCE to receive zero (0) MATCH points in a Playoff MATCH

4.5 DRIVE TEAM

A DRIVE TEAM is a set of up to five (5) people from the same FIRST Robotics Competition Team responsible for Team performance for a specific a MATCH. There are four (4) specific roles on a DRIVE TEAM which ALLIANCES can use to assist ROBOTS with FIRST® POWER UPSM.

Table 4-4: DRIVE TEAM roles

Role	Description	Max./ DRIVE TEAM	Criteria
COACH	a guide or advisor	1	<ul style="list-style-type: none"> Pre-college student or adult mentor Must wear "Coach" button
DRIVER	an operator and controller of the ROBOT	3	<ul style="list-style-type: none"> Pre-college student
HUMAN PLAYER	a POWER CUBE manager		<ul style="list-style-type: none"> Must wear one (1) of the three (3) "Drive Team" buttons
TECHNICIAN	a resource for ROBOT troubleshooting, setup, and removal from the FIELD	1	<ul style="list-style-type: none"> Pre-college student Must wear "Technician" button

The TECHNICIAN is a new role for the 2018 season and provides teams with a technical resource for pre-MATCH setup, ROBOT connectivity, OPERATOR CONSOLE troubleshooting, and post-MATCH removal of the ROBOT. Some pre-MATCH responsibilities for the TECHNICIAN may include, but are not limited to:

- location of the ROBOT radio, its power connection, and understanding of its indicator lights
- location of the roboRIO and understanding of its indicator lights
- username and password for the OPERATOR CONSOLE



- restarting the Driver Station and Dashboard software on the OPERATOR CONSOLE
- changing the bandwidth utilization (e.g. camera resolution, frame rate, etc.)
- changing a battery
- charging pneumatics

While the TECHNICIAN may be the primary technical member of the DRIVE TEAM, all members of the DRIVE TEAM are encouraged to have knowledge of the basic functionality of the ROBOT, such as the location and operation of the main circuit breaker, connecting and resetting joysticks or gamepads from the OPERATOR CONSOLE, and releasing the ROBOT from the SCALE.

4.6 Logistics

Any POWER CUBE that leaves the FIELD will not be returned to MATCH play. POWER CUBES that inadvertently deflect back in to the FIELD will be considered fair game.

Note that ROBOTS may not deliberately cause POWER CUBES to leave the FIELD (see G21), except through the lower opening of the EXCHANGE.

There will not be an ARCADE FAULT called for MATCHES that accidentally begin with an incorrect number of, incorrectly positioned, or damaged POWER CUBES. Damaged POWER CUBES will not be replaced until the next FIELD reset period. DRIVE TEAMS should alert the FIELD STAFF to any missing or damaged POWER CUBES prior to the start of the MATCH.

Once the MATCH is over, if the Head REFEREE determines that the FIELD is safe for FIELD STAFF but not safe for everyone (e.g. the SCALE is full of POWER CUBES that create a falling hazard for a DRIVE TEAM carrying a ROBOT), they will turn the LED lights on the PLATES purple. Once the FIELD is ready for DRIVE TEAM traffic, the Head REFEREE or their designee will change the LED lights to green and DRIVE TEAMS may retrieve their ROBOT in accordance with S02.





5 Safety Rules

Safety is paramount at all times during any Tournament, and each rule below is intended to establish norms at each event that will mitigate injury risk to all participants.

Event staff have the final decision authority for all safety-related issues within a venue.

Veterans of the *FIRST*[®] Robotics Competition may notice the absence of some long-standing rules from this section, e.g. the requirements for safety glasses, closed-toed shoes, and limitations on the wireless use of ROBOTS. These rules remain enforced for the 2018 *FIRST*[®] POWER UPSM season, but have been moved to the [FIRST[®] Robotics Competition Event Experience web page](#) because they are not season specific. As with all violations in this Game Manual any of the Event Experience rules also carry the consequence of a YELLOW or RED CARD.

- S01. Dangerous ROBOTS: not allowed.** ROBOTS whose operation or design is dangerous or unsafe are not permitted.

Violation: If before the MATCH, the offending ROBOT will not be allowed to participate in the MATCH. If during the MATCH, the offending ROBOT will be DISABLED.

Examples include, but are not limited to:

- A. Uncontrolled motion that cannot be stopped by the DRIVE TEAM
- B. ROBOT parts “flailing” outside of the FIELD
- C. ROBOTS dragging their battery
- D. ROBOTS that consistently extend beyond the FIELD

- S02. Wait for the green lights.** DRIVE TEAMS may only enter the FIELD if the LED strings are green, unless explicitly instructed by a REFEREE or an FTA.

Violation: Verbal warning. If repeated, YELLOW CARD. If egregious, RED CARD.

- S03. Never step/jump over the GUARDRAIL.** DRIVE TEAMS may only enter or exit the FIELD through open gates.

Violation: Verbal warning. If repeated, YELLOW CARD. If egregious, RED CARD.

Teams are encouraged to ensure that all members of their DRIVE TEAM are aware of this rule. It's easy to violate, particularly when teams are doing their best to move on and off the FIELD quickly. The violations of S03 are intended to avoid nuisance penalties, but still enforce safety requirements around the FIELD. There is the potential for injury when stepping over the GUARDRAIL.

Violations of S03 apply to the entire team, not specifically to any one individual. For example, a member of team 9999 steps over the GUARDRAIL prior to MATCH 3, and a different member steps over the GUARDRAIL prior to MATCH 25. The team receives a verbal warning for



the first violation and a YELLOW CARD for the second. Jumping over the GUARDRAIL is considered an egregious violation of S03.

S04. Humans, stay off the FIELD during the MATCH. DRIVE TEAMS may not extend any body part into the FIELD during the MATCH.

Violation: YELLOW CARD

Examples of egregious violations that are likely to escalate the Violation to a RED CARD include, but are not limited to, walking onto the FIELD during a MATCH or reaching into the FIELD and grabbing a ROBOT during a MATCH.

S05. ROBOTS, stay on the FIELD during the MATCH. ROBOTS and anything they control, e.g. a POWER CUBE, may not contact anything outside the FIELD with the exception of brief incursions beyond the EXCHANGE or the opening in the PORTAL wall.

Violation: Offending ROBOT will be DISABLED.

Please be conscious of REFEREES, and FIELD STAFF working around the ARCADE who may be in close proximity to your ROBOT.

S06. Stay out of the tunnels. DRIVE TEAMS may not extend any body part into the RETURN chute, the PORTAL chute, or the EXCHANGE tunnel. Momentary encroachment into these volumes is an exception to this rule

Violation: FOUL.





6 Conduct Rules

- C01. Egregious or exceptional violations.** In addition to rule violations explicitly listed in this manual and witnessed by a REFEREE, the Head REFEREE may assign a YELLOW or RED CARD for egregious ROBOT actions or Team member behavior at the event. This includes violations of the event rules found on the [FIRST® Robotics Competition Event Experience web page](#). Please see Section 10.7 YELLOW and RED CARDS for additional detail.
- C02. Be a good person.** All Teams must be civil towards their own Team members, other Teams, competition personnel, FIELD STAFF, and event attendees while at a FIRST® Robotics Competition event.

Violation: Behavior will be discussed with Team or individual. Violations of this rule are likely to escalate to YELLOW or RED CARDS rapidly (i.e. the threshold for egregious or repeated violations is relatively low.)

Examples of inappropriate behavior-include, but are not limited to, repeated use of offensive language or other uncivil conduct.

We've learned that, although intended with no ill will, "clothes pinning" (a game played by some event participants where they try to clip a clothespin to an unsuspecting person) can and does make people uncomfortable. Understandable; it's unwelcome contact that may or may not have been from someone you know and trust. As a result, this is considered an example of uncivil conduct.

- C03. Asking other Teams to throw a MATCH – not cool.** A Team may not encourage an ALLIANCE, of which it is not a member, to play beneath its ability.

NOTE: This rule is not intended to prevent an ALLIANCE from planning and/or executing its own strategy in a specific MATCH in which all the Teams are members of the ALLIANCE.

Violation: Behavior will be discussed with Team or individual. Violations of this rule are likely to escalate rapidly to YELLOW or RED CARDS, and may lead to dismissal from the event (i.e. the threshold for egregious or repeated violations is relatively low.)

Example 1: A MATCH is being played by Teams A, B, and C, in which Team C is encouraged by Team D to not run their AUTO program on their ROBOT, resulting in Teams A, B, and C not being able to earn a Ranking Point for the AUTO QUEST achievement. Team D's motivation for this behavior is to prevent Team A from rising in the Tournament rankings and negatively affecting Team D's ranking.

Example 2: A MATCH is being played by Teams A, B, and C, in which Team A is assigned to participate as a SURROGATE. Team D encourages Team A to not participate in the MATCH so that Team D gains ranking position over Teams B and C.

FIRST® considers the action of a Team influencing another Team to throw a MATCH, to deliberately miss Ranking Points, etc. incompatible with FIRST values and not a strategy any team should employ.

- C04. Letting someone coerce you in to throwing a MATCH – also not cool.** A Team, as the result of encouragement by a Team not on their ALLIANCE, may not play beneath its ability.



NOTE: This rule is not intended to prevent an ALLIANCE from planning and/or executing its own strategy in a specific MATCH in which all the ALLIANCE members are participants.

Violation: Behavior will be discussed with Team or individual. Violations of this rule are likely to escalate rapidly to YELLOW or RED CARDS, and may lead to dismissal from the event (i.e. the threshold for egregious or repeated violations is relatively low.)

Example 1: A MATCH is being played by Teams A, B, and C. Team D requests Team C to not run their AUTO program on their ROBOT, resulting in Teams A, B, and C not earning a Ranking Point for the AUTO QUEST achievement. Team C accepts this request from Team D. Team D's motivation for this behavior is to prevent Team A from rising in the Tournament rankings negatively affecting Team D's ranking.

Example 2: A MATCH is being played by Teams A, B, and C, in which Team A is assigned to participate as a SURROGATE. Team A accepts Team D's request to not participate in the MATCH so that Team D gains ranking position over Teams B and C.

FIRST considers the action of a Team influencing another Team to throw a MATCH, to deliberately miss Ranking Points, etc. incompatible with *FIRST* values and not a strategy any team should employ.

- C05. Compete with only one (1) ROBOT.** Each registered *FIRST* Robotics Competition team may enter only one (1) ROBOT (or 'Robot', which to a reasonably astute observer, is a ROBOT built to play *FIRST*® POWER UPSM) into the 2018 *FIRST* Robotics Competition Season.

"Entering" a ROBOT (or Robot) into a *FIRST* Robotics Competition means bringing it to the event such that it's an aid to your Team (e.g. for spare parts, judging material, or for practice). Spare FABRICATED ITEMS may be brought to the event in a bag or part of a WITHHOLDING ALLOWANCE.

This rule does not prohibit teams from bringing in robots from other *FIRST* programs for the purposes of awards presentations or pit displays.

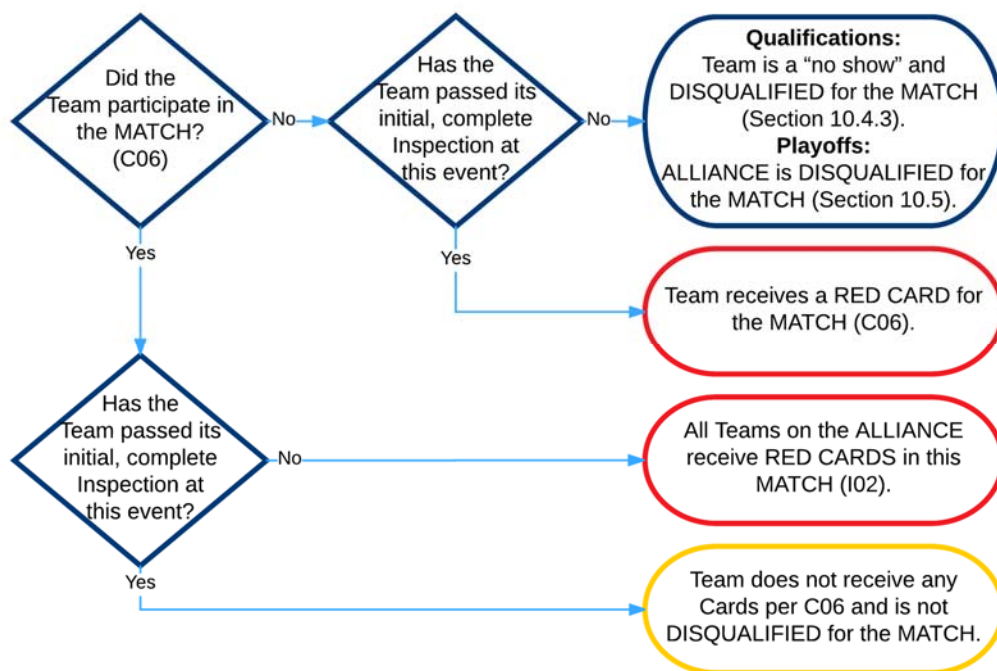
Violation: Verbal warning. Repeated violations will be addressed by the Head REFEREE, the Lead ROBOT Inspector and/or Event Management.

- C06. Show up to your MATCHES.** Each team must send at least one (1) member of its DRIVE TEAM to the FIELD and participate in each of the team's assigned Qualification and Playoff MATCHES. The team should inform the Lead Queuer if the Team's ROBOT is not able to participate.

Violation: If ROBOT has passed an initial, complete Inspection, RED CARD. If ROBOT has not passed an initial, complete Inspection, DISQUALIFIED per I02.



Figure 6-1: Match participation flowchart



- C07. Don't expect to gain by doing others harm.** Strategies clearly aimed at forcing the opposing ALLIANCE to violate a rule are not in the spirit of *FIRST*[®] Robotics Competition and not allowed. Rule violations forced in this manner will not result in an assignment of a penalty to the targeted ALLIANCE.

Violation: FOUL. If egregious or repeated, TECH FOUL and YELLOW CARD.

C07 does not apply for strategies consistent with standard gameplay, for example:

- A. contacting an opponent during the ENDGAME while in your PLATFORM ZONE and attempting to CLIMB.
- B. placing a POWER CUBE on a SCALE PLATE resulting in the opposite PLATE moving upwards into an opponent ROBOT such that the opponent ROBOT ends up violating G25.

C07 requires an intentional act with limited or no opportunity for the TEAM being acted on to avoid the penalty, such as:

- C. placing a POWER CUBE on/in an opponent who's already controlling a POWER CUBE such that they cannot help but violate G22.
- D. forcing an opposing ALLIANCE ROBOT to become wedged under a SCALE PLATE such that they cannot help but violate G16 and/or G25.

- C08. One student, one Head REFEREE.** A Team may only send one (1) pre-college student from its DRIVE TEAM to address the Head REFEREE.



Violation: The Head REFEREE will not address additional, non-compliant Team members or peripheral conversations.

Please see [Section 10.6 REFEREE Interaction](#) for more information about process and expectations.

C09. Plug in to/be in your PLAYER STATION. The OPERATOR CONSOLE must be used in the PLAYER STATION to which the Team is assigned, as indicated on the Team sign.

Violation: The MATCH will not start until the situation is corrected. If during a MATCH, DISABLED.

One intent of C09 is to prevent unsafe situations where long tethers to OPERATOR CONSOLE devices increase tripping hazards as the operator moves about the ALLIANCE STATION. In the interest of avoiding nuisance penalties associated with an operator stepping outside of a prescribed area, we prefer to offer a general guideline as to what it means to use the OPERATOR CONSOLE in the ALLIANCE STATION. Provided the operator is within close proximity of their PLAYER STATION, there will be no repercussions. However, if an operator is located more than approximately ½ PLAYER STATION width away from their own PLAYER STATION, that would be considered a violation of C09.

C10. No work outside your pit. Throughout the event, from load-in to load-out, Teams may only produce FABRICATED ITEMS during pit hours, and:

- a. in their pit area,
- b. in other Teams' pit areas with permission from that team,
- c. while Queued for a MATCH or Practice Field,

Please note that given likely tight quarters, extra scrutiny regarding safety is required.

- d. any area designated by Event Staff (e.g. Playoff Pit Area, etc.), or
- e. as permitted at provided machine shops that are available to all teams.

Violation: Verbal warning. Repeated or egregious violations will be addressed by the Head REFEREE, the Lead ROBOT Inspector and/or Event Management.





7 Game Rules

7.1 Before the MATCH

G01. Know your ROBOT setup. When placed on the FIELD for a MATCH, each ROBOT must be:

- A. in compliance with all ROBOT rules, i.e. has passed Inspection (for exceptions regarding Practice MATCHES, see [Section 9 Inspection & Eligibility Rules](#)),
- B. the only item left on the FIELD by the DRIVE TEAM,
- C. confined to its STARTING CONFIGURATION,
- D. set on the carpet,
- E. in contact with its ALLIANCE WALL diamond plate,
- F. not in contact with the EXCHANGE wall,
- G. not breaking the plane of the EXCHANGE ZONE, and
- H. supporting not more than one (1) POWER CUBE (as described in [Section 4.1.2 MATCH Setup](#)).

Violation: If fix is a quick remedy, the MATCH won't start until all requirements are met. If it is not a quick remedy the offending ROBOT will be DISABLED and, at the discretion of the Head REFEREE, must be re-inspected.

If a ROBOT is BYPASSED prior to the start of the MATCH, the DRIVE TEAM may not remove the ROBOT from the FIELD without permission from the Head REFEREE or the *FIRST*[®] Technical Advisor (FTA).

G02. Be prompt/safe when coming to and going from the FIELD. DRIVE TEAMS may not cause significant or repeated delays to the start of a MATCH and/or to the FIELD reset after the MATCH.

Violation: If prior to the MATCH, the offending DRIVE TEAM'S ROBOT will be DISABLED. If after the MATCH, YELLOW CARD.

DRIVE TEAMS are expected to stage their ROBOTS for a MATCH, and remove it from the FIELD afterwards, safely and swiftly. Examples include, but are not limited to:

- A. late arrival to the FIELD
- B. failing to exit the FIELD once the LED strings have turned off (indicating MATCH ready)
- C. installing BUMPERS, charging pneumatic systems, or any other ROBOT maintenance, once on the FIELD
- D. use of alignment devices that are external to the ROBOT (e.g. a DRIVE TEAM could bring and use a measuring tape, as long as there is no delay to the MATCH by doing so)
- E. failing to remove OPERATING CONSOLES from the PLAYER STATIONS in a timely manner



G03. Know your DRIVE TEAM positions. Prior to the start of the MATCH, DRIVE TEAMS must be positioned as follows:

- A. DRIVERS and COACHES must be in their ALLIANCE STATION and behind the STARTING LINE
- B. HUMAN PLAYERS must be behind the STARTING LINE and either in their ALLIANCE STATION or one of their ALLIANCE PORTALS
- C. TECHNICIANS must be in their designated area outside the ALLIANCE STATION and PORTALS.

Violation: MATCH will not start until the situation is corrected.

The specific location for the TECHNICIAN to stand during a MATCH may vary by event due to space restrictions around the FIELD. In general, TECHNICIANS are located with their Team's ROBOT cart and within close proximity to the FIELD.

G04. Leave the POWER CUBES alone. Prior to the start of the MATCH, DRIVE TEAMS may not rearrange the POWER CUBES within a PORTAL, staged on the FIELD (that are not staged inside a ROBOT), or transfer POWER CUBES from one PORTAL to another.

Violation: MATCH will not start until the situation is corrected.

7.2 ROBOT Restrictions

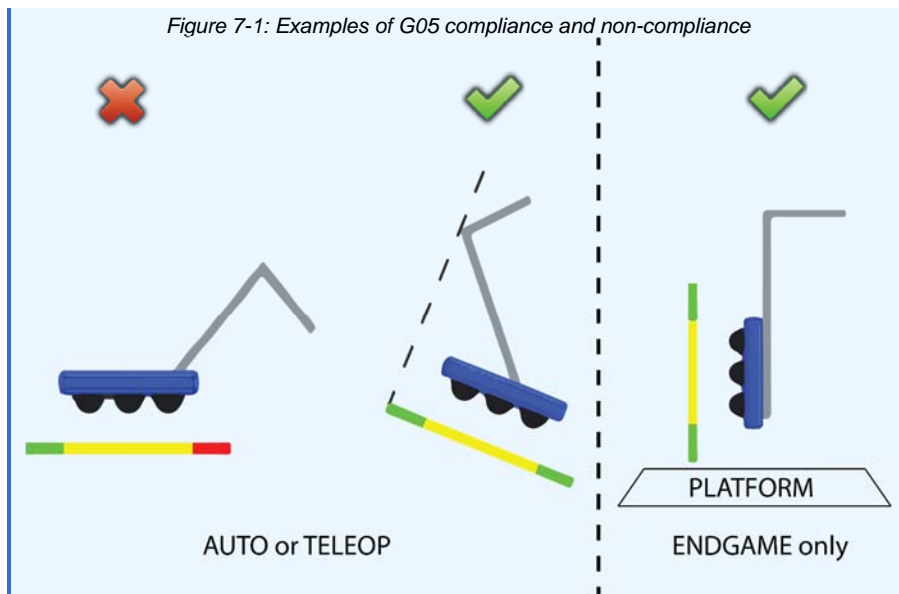
G05. Don't overextend yourself. ROBOTS may not extend more than 16 in (41 cm). beyond their FRAME PERIMETER (see Figure 8-1). This rule doesn't apply to a ROBOT fully within its PLATFORM ZONE during the ENDGAME.

Violation: FOUL. If strategic, (e.g. expansion results in scoring a POWER CUBE), RED CARD.

Teams should be cognizant of venue height, camera poles, lighting trusses etc. when designing their ROBOT.

Examples of compliance and non-compliance of G05 are shown in Figure 7-1.

Yellow bars represent the limits of the FRAME PERIMETER and are drawn in the same orientation of the ROBOT'S FRAME PERIMETER. Green bars represent a measured extension from the FRAME PERIMETER that has not been exceeded. Red bars represent a measured extension from the FRAME PERIMETER that has exceeded the limit in G05). ROBOT A violates G05, whereas ROBOT B and C do not.



G06. Keep it together. ROBOTS may not intentionally detach or leave parts on the FIELD.

Violation: RED CARD

This rule is not intended to penalize ROBOTS that encounter accidental breakage (e.g. a failed MECHANISM that falls off), as those actions are not intentional.

G07. Keep your BUMPERS together. ROBOTS must be in compliance with BUMPER rules throughout the MATCH.

Violation: FOUL. DISABLED if any BUMPER segment becomes completely detached, any side of a ROBOT is completely exposed (without BUMPER), or the Team number or ALLIANCE color becomes indeterminate.

G08. ROBOTS must be removed from the FIELD by hand (i.e. no enabling, power, etc.). ROBOTS will not be re-enabled after the conclusion of the MATCH, nor will Teams be permitted to tether to the ROBOT except in special circumstances (e.g. during TIMEOUTS, after Opening Ceremonies, before an immediate MATCH replay, etc.) and with the express permission from the FTA or a REFEREE.

Violation: YELLOW CARD.

Tethering includes any wired or wireless connection used to electrically energize and/or control elements on the ROBOT. The safety of teams and volunteers in close proximity to ROBOTS and ARCADE elements on the FIELD is of the utmost importance, therefore ROBOTS or ROBOT COMPONENTS may not be energized or powered in any way on the FIELD once the MATCH has concluded.

Keep in mind that ROBOTS need to be safely transported off the FIELD and back to the pits after the MATCH, and there may be bystanders, doorways or height restrictions along the route.

G09. Launching POWER CUBES is okay, but keep it short. A ROBOT is not permitted to launch POWER CUBES except:

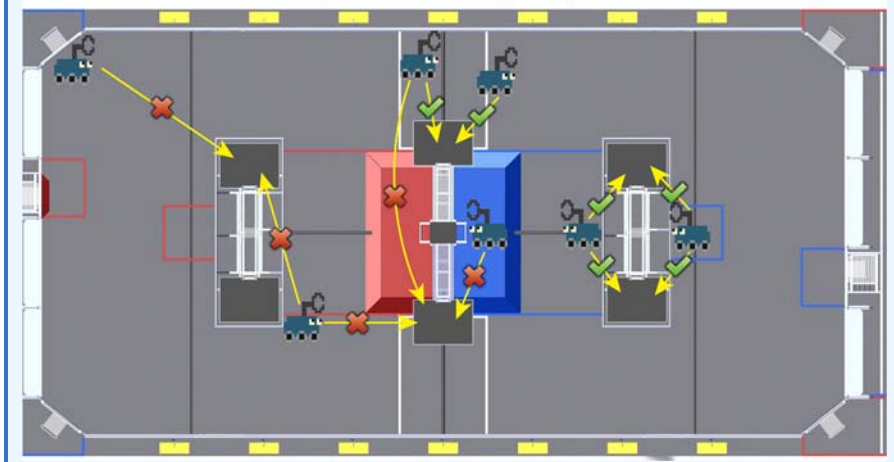
- A. When any part of its BUMPERS are inside its ALLIANCE'S NULL TERRITORY, and it's attempting to place a POWER CUBE on the SCALE PLATE in its ALLIANCE'S NULL TERRITORY, or
- B. when any part of its BUMPERS are contacting a FENCE or any part of the ROBOT is intersecting the vertical planes defined by the SWITCH FENCE, and it's attempting to place a POWER CUBE on the nearest PLATE of that FENCE's SWITCH, or
- C. when any part of its BUMPERS are inside its ALLIANCE'S EXCHANGE ZONE, and it's attempting to place a POWER CUBE in its ALLIANCE'S EXCHANGE tunnel.

Violation: TECH FOUL per POWER CUBE. Repeated violations of this rule are likely to escalate rapidly to YELLOW or RED CARDS

Because gameplay is evaluated by human REFEREES, teams are encouraged to make compliance with G09 (e.g. if any part of the ROBOT is intersecting the vertical planes defined by the SWITCH FENCE) obvious and unambiguous.

A ROBOT in contact with a FENCE and straddling the midpoint (i.e. BUMPERS in both halves of the FIELD) may launch towards either of the corresponding SWITCH'S PLATES.

Figure 7-2: Launching examples



7.3 ROBOT to ROBOT Interaction

- G10. Don't tear others down to lift yourself up.** Strategies aimed at the destruction or inhibition of ROBOTS via attachment, damage, tipping, or entanglements are not allowed.

Violation: FOUL and YELLOW CARD. If harm or incapacitation occurs as a result of the strategy, YELLOW CARD is elevated to a RED CARD

For example, use of a wedge-like MECHANISM to tip ROBOTS is a violation of G10.

MECHANISMS outside the FRAME PERIMETER are particularly susceptible to causing such damage, drawing this penalty, and/or drawing penalties associated with violations of G11.

Teams are encouraged to be cautious in their use of such MECHANISMS when engaging in ROBOT to ROBOT MATCH play.



- G11. Stay out of other ROBOTS.** Initiating deliberate or damaging contact with an opponent ROBOT on or inside the vertical extension of its FRAME PERIMETER, including transitively through a POWER CUBE, is not allowed.

Violation: FOUL and YELLOW CARD.

High speed accidental collisions may occur during the MATCH and are expected. Generally, ROBOTS extend elements outside of the FRAME PERIMETER at their own risk.

A ROBOT with an element outside its FRAME PERIMETER may be penalized under G11 if it appears they are using that element to purposefully contact another ROBOT inside its FRAME PERIMETER.

- G12. Don't collude with your partners to shut down major parts of game play.** Two or more ROBOTS may not isolate or close off any major component of MATCH play, e.g. blocking the EXCHANGE, blocking both PORTALS simultaneously, shutting down all access to POWER CUBES, quarantining all opponents to a small area of the FIELD, etc.

Violation: YELLOW CARD for the ALLIANCE.

A single ROBOT blocking access to a particular area of the FIELD is not a violation of G12.

Two ROBOTS independently playing defense on two opposing ROBOTS is not a violation of this rule.

- G13. If an opponent's down, back off.** Fallen (i.e. tipped over) ROBOTS attempting to right themselves (either by themselves or with assistance from a partner ROBOT) have one ten (10) second grace period in which they may not be contacted by an opponent ROBOT. This protection lasts for either ten (10) seconds or until the protected ROBOT has completed the righting operation, whichever comes first.

Violation: FOUL. If intentional, YELLOW CARD.


- G14. There's a 5-count on pins.** ROBOTS may not pin an opponent's ROBOT for more than five (5) seconds. A ROBOT will be considered pinned until the ROBOTS have separated by at least six (6) feet. The pinning ROBOT(s) must then wait for at least three (3) seconds before attempting to pin the same ROBOT again. Pinning is transitive through other objects. If the pinned ROBOT chases the pinning ROBOT upon retreat, the pinning ROBOT will not be penalized, and the pin will be considered complete.

Violation: FOUL, plus an additional FOUL for every five (5) seconds in which the situation is not corrected. If extended, RED CARD.

There is no *FIRST*[®] Robotics Competition specific definition of pin, so a general definition applies; "to prevent or stop something from moving." As a result, contact is not required for pinning to occur. For example, a ROBOT parked right behind an opponent that is against its PORTAL wall could be considered pinning because the wall and the parked ROBOT prevent the opponent from moving.

Generally, pins that exceed fifteen (15) seconds are considered extended, regardless of a pinning ROBOT's mobility.

- G15. Opponent's EXCHANGE ZONE: no camping.** A ROBOT may not block their opponent's EXCHANGE ZONE for more than five (5) seconds. A ROBOT is considered "blocking" if any part of their ROBOT is breaking the plane of the EXCHANGE ZONE, and will continue to be



considered blocking until the ROBOT has moved at least six (6) feet from the EXCHANGE ZONE. If an opposing ROBOT attempts to stop the blocking ROBOT from moving the required distance to clear the block, the blocking ROBOT will not be penalized, and the block will be considered complete.

A ROBOT that is being pinned is exempt from G15. Once the pin is over, the 5-second count begins for this rule.

Violation: FOUL, plus an additional FOUL for every five (5) seconds in which the situation is not corrected. If extended and egregious, YELLOW CARD.

Generally, blocking that exceeds fifteen (15) seconds is considered extended and egregious, regardless of a blocking ROBOT's mobility, however circumstances vary and the assessment is open to REFEREE discretion.

- G16. The NULL TERRITORY is safe.** A ROBOT whose BUMPERS are breaking the plane of its NULL TERRITORY and not breaking the plane of the opponent's PLATFORM ZONE may not be contacted by an opposing ROBOT, regardless of who initiates the contact. A ROBOT forced into breaking the plane of an opponent's NULL TERRITORY resulting in it being wedged underneath the SCALE is not a violation of this rule.

Violation: TECH FOUL

TEAMS should note that they are putting themselves at great risk of TECH FOULS near their opponent's NULL TERRITORY.

- G17. Don't climb on each other until the end.** Unless during the ENDGAME, or attempting to right a fallen (i.e. tipped over) ALLIANCE partner, ROBOTS may neither fully nor partially strategically support the weight of partner ROBOTS.

Violation: TECH FOUL.

- G18. Don't mess with opponents in their PLATFORM ZONE.** During the ENDGAME, ROBOTS may not contact an opponent ALLIANCE ROBOT, completely contained within their ALLIANCE'S PLATFORM ZONE, regardless of who initiates the contact.

Violation: The contacted opponent ROBOT, and all partner ROBOTS it's fully supporting, are considered to have CLIMBED at the end of the MATCH.

Teams are encouraged to consider rule [C07](#) when developing their strategies, such as attempting to draw violations of this rule.

7.4 FIELD Interaction

- G19. Be careful about what you interact with.** DRIVE TEAMS, ROBOTS, and OPERATOR CONSOLES are prohibited from the following actions with regards to interaction with ARCADE elements.

Items A and B exclude DRIVE TEAM interaction with FIELD elements in their areas.

Item C excludes use of the PLAYER STATION hook-and-loop tape, plugging in to the provided power outlet, and plugging the provided Ethernet cable in to the OPERATOR CONSOLE.

Items A-D exclude RUNGS and POWER CUBES.

- A. Grabbing
- B. Grasping



- C. Attaching to (including the use of hook-and-loop tape against the FIELD carpet)
- D. Hanging
- E. Deforming
- F. Becoming entangled
- G. Damaging

Violation: If prior to MATCH, and situation can be corrected quickly, it must be remedied before the MATCH will start. If during a MATCH, FOUL. If during a MATCH and extended or repeated, YELLOW CARD. If offense is via a ROBOT and the Head REFEREE determines that further damage is likely to occur, offending ROBOT will be DISABLED. Corrective action (such as eliminating sharp edges, removing the damaging MECHANISM, and/or re-Inspection) may be required before the ROBOT will be allowed to compete in subsequent MATCHES.

POWER CUBES are expected to undergo a reasonable amount of wear and tear as they are handled by ROBOTS, such as scratching, marking, or small cracks. Gouging, tearing off pieces, routinely marking POWER CUBES, or causing large cracks that weaken rigidity are violations of this rule. Humans causing POWER CUBE wear and tear, e.g. slicing a POWER CUBE, are subject to a CARD per C01.

- G20. POWER CUBES: use as directed.** With the exception of placing a POWER CUBES on PLATES, ROBOTS may not deliberately use POWER CUBES in an attempt to ease or amplify the challenge associated with FIELD elements.

Violation: TECH FOUL per POWER CUBE. Repeated or egregious violations of this rule are likely to escalate rapidly to YELLOW or RED CARDS.

Examples include, but are not limited to:

- A. stacking POWER CUBES underneath a PLATE

- B. climbing on POWER CUBES
- C. using POWER CUBES to explicitly impede opponent mobility
- D. Placing a POWER CUBE on the top of the SCALE to block the opponent ALLIANCE RUNGS is an egregious violation of G20.

- G21. Keep POWER CUBES in bounds.** With the exception of feeding POWER CUBES through the lower opening of the EXCHANGE, ROBOTS may not intentionally eject POWER CUBES from the FIELD.

Violation: FOUL per POWER CUBE. Repeated violations of this rule are likely to escalate rapidly to YELLOW or RED CARDS.

- G22. One POWER CUBE per ROBOT.** ROBOTS may not control more than one (1) POWER CUBE at a time.

Violation: FOUL per additional POWER CUBE. Repeated violations of this rule are likely to escalate rapidly to YELLOW or RED CARDS

Moving or positioning a POWER CUBE to gain advantage is considered "control." Examples include, but are not limited to:



- A. “carrying” (holding a POWER CUBE inside a ROBOT)
- B. “herding” (intentionally pushing a POWER CUBE to a desired location or direction)
- C. “trapping” (holding a POWER CUBE against a FIELD element in an attempt to shield or guard it)
- D. “launching” (shooting POWER CUBES into the air, kicking across the floor, or throwing in a forceful way)

Examples of interaction with POWER CUBES that are not “control” include, but are not limited to:

- E. “bulldozing” (inadvertent contact with POWER CUBES while in the path of the ROBOT moving about the FIELD)
- F. “deflecting” (being hit by a POWER CUBE that bounces into or off of a ROBOT)
- G. “plowing” (brief contact with a large quantity of POWER CUBES while attempting to break up a pile, or gain access to an area of the FIELD. Sustained contact or contact after the brief plowing action will be subject to “herding”)
- H. “nudging” (contact with a POWER CUBE that is on a PLATE while attempting to place additional POWER CUBES on that PLATE)

If a POWER CUBE becomes lodged in or on a ROBOT, it will be considered controlled by the ROBOT. It is important to design your ROBOT so that it is impossible to inadvertently or unintentionally control more than the allowed maximum.

- G23. POWER CUBES in opponent’s POWER CUBE ZONE – off limits.** ROBOTS may not remove POWER CUBES, or cause POWER CUBES to be removed, from the opponent’s POWER CUBE ZONE. A POWER CUBE has been removed from the POWER CUBE ZONE when it starts fully contained by the POWER CUBE ZONE, and ends completely outside of the POWER CUBE ZONE. A POWER CUBE removed through transitive contact with another POWER CUBE and/or an opponent ROBOT is a violation of this rule.

Violation: FOUL per POWER CUBE removed

- G24. POWER CUBES stay on PLATES.** Strategies aimed at removing POWER CUBES from PLATES are prohibited.

Violation: TECH FOUL per POWER CUBE removed

Examples of actions that violate this rule include, but are not limited to:

- using an arm to sweep POWER CUBES off a PLATE.
- launching a POWER CUBE at a stack on an opponent’s PLATE, causing the stack to topple.

- G25. PLATES are moved by POWER CUBES, not ROBOTS.** Except via the weight of placed POWER CUBES, ROBOTS may not directly or transitively cause or prevent the movement of PLATES. Movement, or prevention of movement, of PLATES because of momentary ROBOT action resulting in minimal PLATE displacement is not a violation of this rule. A ROBOT forced to affect the position of a PLATE because of contact by an opponent ROBOT either directly or transitively through a POWER CUBE or other ROBOT (e.g. a ROBOT wedged underneath the



SCALE by the opposing ALLIANCE either intentionally or accidentally) is not a violation of this rule.

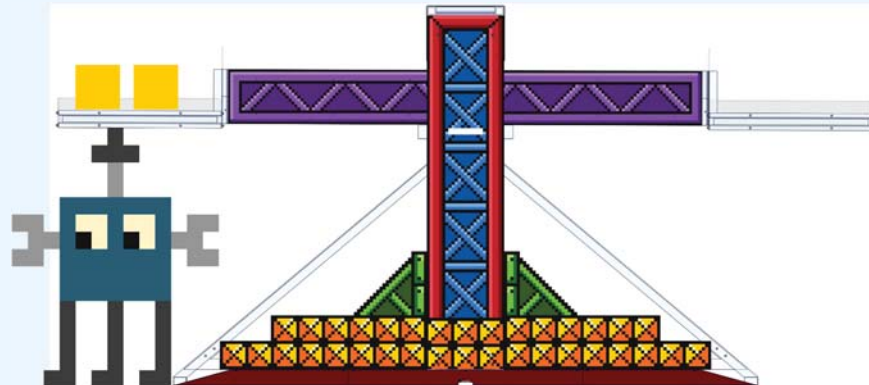
Violation: FOUL per instance plus an additional TECH FOUL for every five (5) seconds in which the situation is not corrected. Repeated or extended violations of this rule are likely to escalate rapidly to YELLOW or RED CARDS.

The intent of G25 is to make it clear that PLATES are to move solely because of POWER CUBE weight and not because of a ROBOT deliberately trying to move PLATES (either by using its own manipulator, or a POWER CUBE as an extension of the ROBOT, to push or hold a PLATE).

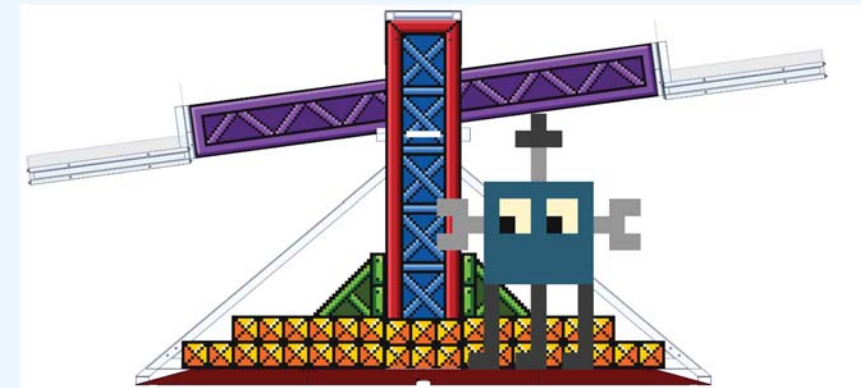
The “momentary” and “minimal” language in G25 is subjective but necessary because ROBOTS may cause PLATE movement (or prevent PLATE movement) as they place POWER CUBES and bump PLATES, get hit, etc.

Generally, “momentary” means near instantaneous, or in other words, contact for less than approximately one (1) second and “minimal” means a displacement of fewer than approximately three (3) in. However, REFEREES are not expected to measure, and be accountable to, real-time PLATE displacement or precise timing from their vantage points.

Example 1: A ROBOT may not hold the SCALE PLATE in a “balanced” state.



Example 2: A ROBOT may not hold a plate up.





7.5 AUTO Period Rules

- A01. Behind the lines.** During AUTO, DRIVE TEAM members in ALLIANCE STATIONS and PORTALS may not contact anything in front of the STARTING LINES, unless for personal or equipment safety.

Violation: FOUL per item contacted.

Pointing, gesturing or otherwise extending across the STARTING LINE such that contact is not made with carpet or other ARCADE elements is not a violation of this rule.

One example of an exception for equipment safety is if an OPERATOR CONSOLE starts to slide from, or has already fallen off of, the PLAYER STATION shelf. In that circumstance, DRIVE TEAM members may step forward to catch it, or pick it up off the ground, and return it to the shelf.

- A02. During AUTO, let the ROBOT do its thing.** During AUTO, DRIVE TEAMS may not directly or indirectly interact with ROBOTS or OPERATOR CONSOLES unless for personal safety, OPERATOR CONSOLE safety, or pressing an E-Stop for ROBOT safety.

Violation: FOUL and YELLOW CARD.

Making an adjustment to the OPERATOR CONSOLE or interacting with the ROBOT after the assignment of PLATE colors is a violation of this rule. Teams can use the information from the FMS to determine PLATE color assignments using preprogrammed instructions (see Section 3.10).

- A03. Disconnect or set down controllers.** During AUTO, any control devices worn or held by the DRIVERS and/or HUMAN PLAYERS must be disconnected from the OPERATOR CONSOLE.

Violation: FOUL.

For the purposes of the *FIRST* Robotics Competition, any device connected to the OPERATOR CONSOLE is considered a control device because REFEREES are not expected to differentiate between devices that can or cannot control the ROBOT.

- A04. Stay out of your opponent's side of the FIELD.** During AUTO, no part of a ROBOT'S BUMPERS may pass from the NULL TERRITORY to the opponent's side of the FIELD.

Violation: FOUL. If contact is made with an opponent ROBOT in their side of the FIELD (either direct contact or transitive contact through a POWER CUBE), TECH FOUL. Violations of this rule are likely to escalate rapidly to YELLOW or RED CARDS.

- A05. POWER CUBES are off-limits.** During AUTO, DRIVE TEAMS may not contact any POWER CUBES, unless for personal safety.

Violation: FOUL per POWER CUBE.

7.6 Human Action Rules

- H01. COACHES and other Teams: hands off the controls.** A ROBOT shall be operated solely by the DRIVERS and/or HUMAN PLAYERS of that Team.

Violation: Offending ROBOT will be DISABLED.

Exceptions may be made before a MATCH for major conflicts, e.g. religious holidays, major testing, transportation issues, etc.



H02. Wireless devices not allowed. During a MATCH, DRIVE TEAMS may not use electronic devices which have the capability of receiving communications from persons outside of the ARCADE (e.g. cell phones or wearable technology).

Violation: YELLOW CARD.

H03. Don't trick the sensors. Teams may not interfere with any automated scoring hardware.

Violation: RED CARD for the ALLIANCE.

A POWER CUBE must rest on any of its six (6) faces when placed within a column of the VAULT. Failure to do so may result in a violation of H03.

H04. By invitation only. Only DRIVE TEAMS for the current MATCH are allowed in their respective ALLIANCE STATIONS or PORTALS.

Violation: MATCH will not start until the situation is corrected.

H05. Identify yourself. DRIVE TEAMS must wear proper identification while in the ARCADE. Proper identification consists of:

- A.** All DRIVE TEAM members wearing their designated buttons above the waist in a clearly visible location at all times while in the ARCADE.
 - i.** The COACH wearing the "Coach" labeled DRIVE TEAM button
 - ii.** The DRIVERS and HUMAN PLAYERS each wearing a DRIVE TEAM button
 - iii.** The TECHNICIAN wearing the "Technician" labeled DRIVE TEAM button
- B.** During a Playoff MATCH, the ALLIANCE CAPTAIN clearly displaying the designated ALLIANCE CAPTAIN identifier (e.g. hat or armband).

Violation: MATCH will not start until the situation is corrected. Those not displaying identification must leave the ARCADE.

H06. No wandering. DRIVE TEAM members may not contact anything outside the zone in which they started the MATCH (e.g. the ALLIANCE STATION, PORTAL, designated area for the TECHNICIAN) during the MATCH. Exceptions will be granted for inadvertent, momentary, and inconsequential infractions and in cases concerning safety.

Violation: FOUL. If strategic, RED CARD.

H07. You can't bring/use anything you want. The only equipment that may be brought to the ARCADE and used by DRIVE TEAMS during a MATCH is listed below. Regardless if equipment fits criteria below, it may not be employed in a way that breaks any other rules, introduces a safety hazard (e.g. a step stool or large signaling device in the confined space of the PORTAL are safety concerns), blocks visibility for FIELD STAFF or audience members, or jams or interferes with the remote sensing capabilities of another Team, or the FIELD, including vision systems, acoustic range finders, sonars, infrared proximity detectors, etc. (e.g. including imagery that, to a reasonably astute observer, mimics the Vision Targets used on the FIELD).

- A.** the OPERATOR CONSOLE,
- B.** non-powered signaling devices,
- C.** reasonable decorative items,
- D.** special clothing and/or equipment required due to a disability,
- E.** devices used solely for planning or tracking strategy,
- F.** devices used solely to record gameplay,



- G. non-powered Personal Protective Equipment (examples include, but aren't limited to, gloves, eye protection, and hearing protection)

Items brought to the ARCADE under allowances B-G must meet all of the following conditions:

- i. do not connect or attach to the OPERATOR CONSOLE
- ii. do not connect or attach to the FIELD or ARCADE
- iii. do not connect or attach to another ALLIANCE member (other than items in category G)
- iv. do not communicate with anything or anyone outside of the ARCADE.
- v. do not communicate with the TECHNICIAN
- vi. do not include any form of enabled wireless electronic communication (e.g. radios, walkie-talkies, cell phones, Bluetooth communications, Wi-Fi, etc.)
- vii. do not in any way affect the outcome of a MATCH, other than by allowing the DRIVE TEAM to
 - a. plan or track strategy for the purposes of communication of that strategy to other ALLIANCE members or
 - b. use items allowed per part B to communicate with the ROBOT (provided A02 is not violated).

Violation: MATCH will not start until situation remedied. If discovered or used inappropriately during a MATCH, YELLOW CARD.

- H08. Don't abuse ARCADE access.** Team members (except DRIVERS, HUMAN PLAYERS, and COACHES) who are granted access to restricted areas in and around the ARCADE (e.g. via TECHNICIAN button, event issued Media badges, etc.) may not coach or use signaling devices during the MATCH. Exceptions will be granted for inconsequential infractions and in cases concerning safety.

Violation: YELLOW CARD

The TECHNICIAN's role is help the team prepare the ROBOT so it can perform at its full potential during a MATCH. The TECHNICIAN is not an additional COACH, DRIVER or HUMAN PLAYER.

- H09. Don't mess with the POWER CUBES.** Teams may not modify POWER CUBES in any way.

Violation: RED CARD.

Opening the zipper pockets on a POWER CUBE to add additional weight, or cracking / bending a POWER CUBE, are examples of violations.

- H10. It doesn't support you.** Teams may not sit or stand on POWER CUBES.

Violation: Behavior will be discussed with Team or individual. Violations of this rule are likely to escalate rapidly to YELLOW or RED CARDS.

- H11. COACHES, no POWER CUBES.** During a MATCH, COACHES may not touch POWER CUBES unless for safety purposes.

Violation: TECH FOUL per instance.

- H12. COACHES, stay clear of the VAULT.** During a MATCH, COACHES may not touch any component of the VAULT (including the buttons) unless for safety purposes.



Violation: TECH FOUL per instance

H13. POWER CUBES only enter the FIELD as designated. DRIVE TEAMS may only deliberately cause POWER CUBES to leave an ALLIANCE STATION or PORTAL

- A. during TELEOP,
- B. by a HUMAN PLAYER or DRIVER, and
- C. through a PORTAL wall or the RETURN

Violation: FOUL per POWER CUBE. If strategic, RED CARD.

An example of a strategic violation of this rule would be transferring a POWER CUBE from an ALLIANCE'S PORTAL to the opponent's ALLIANCE STATION in order for it to be used in the opponent's VAULT.

Note that H13 prohibits returning a POWER CUBE to the FIELD through the lower opening on the EXCHANGE wall, only the upper (RETURN) opening.

H14. POWER CUBES stay in the VAULT. POWER CUBES may not be removed from the VAULT.

Violation: FOUL. If strategic (i.e. re-used in a different column within the VAULT or introduced to the FIELD), RED CARD.

A POWER CUBE is considered in the VAULT when the LEDs in the corresponding column indicate its presence.





8 ROBOT Rules

This section of the 2018 *FIRST*[®] Robotics Competition Game Manual presents legislation relevant to the construction of a 2018 *FIRST*[®] Robotics Competition ROBOT. ROBOTS must pass Inspection at each *FIRST*[®] Robotics Competition event to confirm compliance before being allowed to compete, per [Section 9 Eligibility & Inspection](#).

8.1 Overview

The rules listed below explicitly address legal parts and materials and how those parts and materials may be used on a 2018 ROBOT. There are many reasons for the structure of the rules, including safety, reliability, parity, creation of a reasonable design challenge, adherence to professional standards, impact on the competition, and compatibility with the Kit of Parts (KOP). The KOP is the collection of items listed on any Kickoff Kit Checklists, distributed via *FIRST*[®] Choice, or paid for completely (except shipping) with a Product Donation Voucher (PDV).

Another intent of these rules is to have all energy sources and active actuation systems on the ROBOT (e.g. batteries, compressors, motors, servos, cylinders, and their controllers) drawn from a well-defined set of options. This is to ensure that all teams have access to the same actuation resources and that the Inspectors are able to accurately and efficiently assess the legality of a given part.

ROBOTS are made up of COMPONENTS and MECHANISMS. A COMPONENT is any part in its most basic configuration, which cannot be disassembled without damaging or destroying the part or altering its fundamental function. A MECHANISM is a COTS or custom assembly of COMPONENTS that provide specific functionality on the ROBOT. A MECHANISM can be disassembled (and then reassembled) into individual COMPONENTS without damage to the parts.

Many rules in this section reference Commercial-Off-The-Shelf (COTS) items. A COTS item must be a standard (i.e. not custom order) part commonly available from a VENDOR for all teams for purchase. To be a COTS item, the COMPONENT or MECHANISM must be in an unaltered, unmodified state (with the exception of installation or modification of any software). Items that are no longer commercially available but are functionally equivalent to the original condition as delivered from the VENDOR are considered COTS and may be used.

- Example 1: A Team orders two (2) ROBOT grippers from RoboHands Corp. and receives both items. They put one in their storeroom and plan to use it later. Into the other, they drill “lightening holes” to reduce weight. The first gripper is still classified as a COTS item, but the second gripper is now a FABRICATED ITEM, as it has been modified.
- Example 2: A Team obtains openly available blueprints of a drive module commonly available from Wheels-R-Us Inc. and has local machine shop “We-Make-It, Inc.” manufacture a copy of the part for them. The produced part is NOT a COTS item, because it is not commonly carried as part of the standard stock of We-Make-It, Inc.
- Example 3: A Team obtains openly available design drawings from a professional publication during the pre-season, and uses them to fabricate a gearbox for their ROBOT during the build period following Kickoff. The design drawings are considered a COTS item, and may be used as “raw material” to fabricate the gearbox. The finished gearbox itself would be a FABRICATED ITEM, and not a COTS item.




- Example 4: A COTS part that has non-functional label markings added would still be considered a COTS part, but a COTS part that has device-specific mounting holes added is a FABRICATED ITEM.
- Example 5: A team has a COTS single-board processor version 1.0, which can no longer be purchased. Only the COTS single-board processor version 2.0 may be purchased. If the COTS single-board processor version 1.0 is functionally equivalent to its original condition, it may be used.
- Example 6: A team has a COTS gearbox which has been discontinued. If the COTS gearbox is functionally equivalent to its original condition, it may be used.

A **VENDOR** is a legitimate business source for COTS items that satisfies all of the following criteria:

- A. has a Federal Tax Identification number. In cases where the **VENDOR** is outside of the United States, they must possess an equivalent form of registration or license with the government of their home nation that establishes and validates their status as a legitimate business licensed to operate within that country.
- B. is not a “wholly owned subsidiary” of a *FIRST* Robotics Competition Team or collection of Teams. While there may be some individuals affiliated with both a Team and the **VENDOR**, the business and activities of the Team and **VENDOR** must be completely separable.
- C. must be able to ship any general (i.e., non-*FIRST* unique) product within five business days of receiving a valid purchase request. It is recognized that certain unusual circumstances (such as 1,000 *FIRST* Teams all ordering the same part at once from the same **VENDOR**) may cause atypical delays in shipping due to backorders for even the largest **VENDORS**. Such delays due to higher-than-normal order rates are excused.
- D. should maintain sufficient stock or production capability to fill Teams’ orders within a reasonable period during the season (less than 1 week). (Note that this criterion may not apply to custom-built items from a source that is both a **VENDOR** and a fabricator. For example, a **VENDOR** may sell flexible belting that the Team wishes to procure to use as treads on their drive system. The **VENDOR** cuts the belting to a custom length from standard shelf stock that is typically available, welds it into a loop to make a tread, and ships it to a Team. The fabrication of the tread takes the **VENDOR** two weeks. This would be considered a FABRICATED ITEM, and the two-week ship time is acceptable.) Alternately, the Team may decide to fabricate the treads themselves. To satisfy this criterion, the **VENDOR** would just have to ship a length of belting from shelf stock (i.e. a COTS item) to the Team within five business days and leave the welding of the cuts to the Team.)
- E. makes their products available to all *FIRST* Robotics Competition Teams. A **VENDOR** must not limit supply or make a product available to just a limited number of *FIRST* Robotics Competition Teams.

The intent of this definition is to be as inclusive as possible to permit access to all legitimate sources, while preventing ad hoc organizations from providing special-purpose products to a limited subset of Teams in an attempt to circumvent the cost accounting rules.

FIRST desires to permit Teams to have the broadest choice of legitimate sources possible, and to obtain COTS items from the sources that



provide them with the best prices and level of service available. Teams also need to protect against long delays in availability of parts that will impact their ability to complete their ROBOT. The build season is brief, so the VENDOR must be able to get their product, particularly *FIRST* unique items, to a Team in a timely manner.

Ideally, chosen VENDORS should have national distributors (e.g. Home Depot, Lowes, MSC, Radio Shack, McMaster-Carr, etc.). Remember, *FIRST* Robotics Competition events are not always near home – when parts fail, local access to replacement materials is often critical.

A FABRICATED ITEM is any COMPONENT or MECHANISM that has been altered, built, cast, constructed, concocted, created, cut, heat treated, machined, manufactured, modified, painted, produced, surface coated, or conjured partially or completely into the final form in which it will be used on the ROBOT.

Note that it is possible for an item (typically raw materials) to be neither COTS nor a FABRICATED ITEM. For example, a 20 ft. length of aluminum which has been cut into 5 ft. (~152 cm) pieces by the Team for storage or transport is neither COTS (it's not in the state received from the VENDOR), nor a FABRICATED ITEM (the cuts were not made to advance the part towards its final form on the ROBOT).

Teams may be asked to provide documentation proving legality of non-2018 KOP items during Inspection where a Rule specifies limits for a legal part (e.g. pneumatic items, current limits, COTS electronics, etc.).

Some of these rules make use of English unit requirements for parts. If your team has a question about a metric-equivalent part's legality, please e-mail your question to frcparts@firstinspires.org for an official ruling. To seek approval for alternate devices for inclusion in future *FIRST* Robotic Competition seasons, please contact frcparts@firstinspires.org with item specifications.

Teams should acknowledge the support provided by the corporate Sponsors and Mentors with an appropriate display of their school and Sponsors names and/or logos (or the name of the supporting youth organization, if appropriate).

FIRST Robotics Competition can be a full-contact competition and may include rigorous game play. While the rules aim to limit severe damage to ROBOTS, Teams should design their ROBOTS to be robust.

8.2 General ROBOT Design

- R01.** The ROBOT (excluding BUMPERS) must have a FRAME PERIMETER, contained within the BUMPER ZONE, that is comprised of fixed, non-articulated structural elements of the ROBOT. Minor protrusions no greater than $\frac{1}{4}$ in. (~6.3 mm) such as bolt heads, fastener ends, weld beads, and rivets are not considered part of the FRAME PERIMETER.

To determine the FRAME PERIMETER, wrap a piece of string around the ROBOT (excluding BUMPERS) at the BUMPER ZONE described in R24 and pull it taut. The string outlines the FRAME PERIMETER.

Example: A ROBOT's chassis is shaped like the letter 'V', with a large gap between chassis elements on the front of the ROBOT. When wrapping a taut string around this chassis, the string extends across the gap and the resulting FRAME PERIMETER is a triangle with three sides.

Note: to permit a simplified definition of the FRAME PERIMETER and encourage a tight, robust connection between the BUMPERS and the FRAME PERIMETER, minor protrusions such as bolt heads, fastener

ends, rivets, etc. are excluded from the determination of the FRAME PERIMETER.

- R02.** In the STARTING CONFIGURATION (the physical configuration in which a ROBOT starts a MATCH), no part of the ROBOT shall extend outside the vertical projection of the FRAME PERIMETER, with the exception of its BUMPERS and minor protrusions such as bolt heads, fastener ends, rivets, cable ties, etc.

If a ROBOT is designed as intended and each side is pushed up against a vertical wall (in STARTING CONFIGURATION and with BUMPERS removed), only the FRAME PERIMETER (or minor protrusions) will be in contact with the wall.

The allowance for minor protrusions in R02 is intended to allow protrusions that are both minor in extension from the FRAME PERIMETER and cross sectional area.

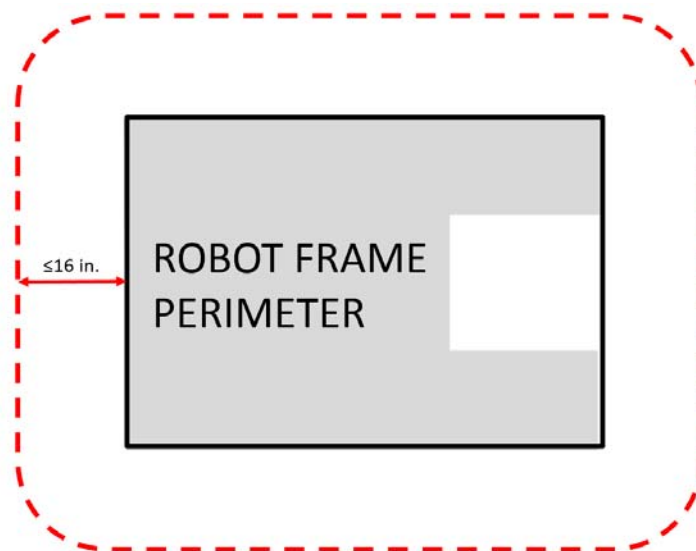
- R03.** In the STARTING CONFIGURATION, the maximum ROBOT size (excluding BUMPERS) must be constrained to a volume of 33 in. by 28 in. by 55 in. tall (~83 cm by ~71 cm by ~139 cm tall). Minor protrusions permitted in R01 and R02 (that are less than ¼ in. (~6.3 mm) such as bolt heads, fastener ends, weld beads, and rivets) are exempt from the 33 in. and 28 in. limits.

Expect to have to demonstrate a ROBOT'S ability to constrain itself per above during Inspection. Constraints may be implemented with either hardware or software.


Be sure to consider the size of the ROBOT on its cart to make sure it will fit through doors. Also consider the size of the ROBOT to ensure that it will fit into a shipping crate, bag, vehicle, etc.

- R04.** ROBOTS may not extend more than 16 in. (~40 cm) beyond their FRAME PERIMETER (see Figure 8-1), except during the ENDGAME (see G05).

Figure 8-1: FRAME PERIMETER Extension



- R05.** The ROBOT weight must not exceed 120 lbs. When determining weight, the basic ROBOT structure and all elements of all additional MECHANISMS that might be used in different configurations of the ROBOT shall be weighed together (see I03).



For the purposes of determining compliance with the weight limitations, the following items are excluded:

- A. ROBOT BUMPERS
- B. ROBOT battery and its associated half of the Anderson cable quick connect/disconnect pair (including no more than 12 in. (~30 cm) of cable per leg, the associated cable lugs, connecting bolts, and insulation)

8.3 ROBOT Safety & Damage Prevention

- R06. Traction devices must not have surface features such as metal, sandpaper, hard plastic studs, cleats, hook-loop fasteners or similar attachments that could damage the ARCADE. Traction devices include all parts of the ROBOT that are designed to transmit any propulsive and/or braking forces between the ROBOT and FIELD carpet.
- R07. Protrusions from the ROBOT and exposed surfaces on the ROBOT shall not pose hazards to the ARCADE elements (including the POWER CUBES) or people.

If the ROBOT includes protrusions that form the “leading edge” of the ROBOT as it drives and the protrusions have a surface area of less than 1 in.² (~6 cm²), it will invite detailed Inspection. For example, forklifts, lifting arms, or grapplers may be carefully inspected for these hazards.

- R08. ROBOT parts shall not be made from hazardous materials, be unsafe, cause an unsafe condition, or interfere with the operation of other ROBOTS.

Examples of items that will violate R08 include (but are not limited to):

- A. Shields, curtains, or any other devices or materials designed or used to obstruct or limit the vision of any DRIVERS and/or COACHES and/or interfere with their ability to safely control their ROBOT
- B. Speakers, sirens, air horns, or other audio devices that generate sound at a level sufficient to be a distraction
- C. Any devices or decorations specifically intended to jam or interfere with the remote sensing capabilities of another ROBOT, including vision systems, acoustic range finders, sonars, infrared proximity detectors, etc. (e.g. including imagery on your ROBOT that, to a reasonably astute observer, mimics the retro-reflective features of vision targets described in [Section 3.9 Vision Targets](#))
- D. Exposed lasers other than Class I.
- E. Flammable gasses
- F. Any device intended to produce flames or pyrotechnics
- G. Hydraulic fluids or hydraulic items
- H. Switches or contacts containing liquid mercury
- I. Circuitry used to create voltages in excess of 24 Volts
- J. Any ballast not secured sufficiently, including loose ballast e.g. sand, ball bearings, etc., such that it may become loose during a MATCH.
- K. Exposed, untreated hazardous materials (e.g. lead weights) used on the ROBOT. These materials may be permitted if painted, encapsulated or otherwise sealed to prevent contact. These materials may not be machined in any way at an event.



- L. Tire sealant
- M. High intensity light sources used on the ROBOT (e.g. super bright LED sources marketed as 'military grade' or 'self-defense') may only be illuminated for a brief time while targeting and may need to be shrouded to prevent any exposure to participants. Complaints about the use of such light sources will be followed by re-inspection and possible disablement of the device.
Teams should provide MSD Sheets for any materials they use that might be considered questionable during ROBOT Inspection.

R09. ROBOTS must allow removal of POWER CUBES from the ROBOT and the ROBOT from FIELD elements while DISABLED and powered off.

ROBOTS will not be re-enabled after the MATCH, so Teams must be sure that POWER CUBES and ROBOTS can be quickly, simply, and safely removed.

R10. Lubricants may be used only to reduce friction within the ROBOT. Lubricants must not contaminate the ARCADE or other ROBOTS.

8.4 Budget Constraints & Fabrication Schedule

R11. The total cost of all items on the ROBOT shall not exceed \$4000 USD. All costs are to be determined as explained in [Section 8.4 Budget Constraints & Fabrication Schedule](#). Exceptions are as follows:

- A. individual items that are less than \$5 USD each, as purchasable from a VENDOR, and
- B. KOP items

Teams should be prepared to disclose to Inspectors the cost of any non-KOP item and the total cost of the ROBOT.

Per I05, Teams must be prepared to display a Cost Accounting Worksheet (CAW) to Inspectors during Inspection. The CAW may be displayed in either printed or electronic form.

If the item is a KOP item, it does not need to be on the CAW.

Individual COMPONENTS or MECHANISMS, not excluded in R11, that are retrieved from previous ROBOTS and used on 2018 ROBOTS must have their undepreciated cost included in the 2018 CAW and applied to the overall cost assessment.

R12. No individual, non-KOP item shall have a value that exceeds \$500 USD. The total cost of COMPONENTS purchased in bulk may exceed \$500 USD as long as the cost of an individual COMPONENT does not exceed \$500 USD.

If a COTS item is part of a modular system that can be assembled in several possible configurations, then each individual module must fit within the price constraints defined in R12.

If the modules are designed to assemble into a single configuration, and the assembly is functional in only that configuration, then the total cost of the complete assembly including all modules must fit within the price constraints defined in R12.

In summary, if a VENDOR sells a system or a kit, a team must use the entire system/kit Fair Market Value and not the value of its COMPONENT pieces.

Example 1: VENDOR A sells a gearbox that can be used with a number of different gear sets, and can mate with two different motors they sell. A team purchases the gearbox, a gear set, and a motor (which are not offered together as an assembly or kit), then assembles them together. Each part is treated separately for the purpose of CAW costing, since the purchased pieces can each be used in various configurations.

Example 2: VENDOR B sells a robotic arm assembly that the team wants to use. However, it costs \$700 USD, so they cannot use it. The VENDOR sells the “hand”, “wrist”, and “arm” as separate assemblies, for \$200 USD each. A team wishes to purchase the three items separately, then reassemble them. This would not be legal, as they are really buying and using the entire assembly, which has a Fair Market Value of \$700 USD.

Example 3: VENDOR C sells a set of wheels or wheel modules that are often used in groups of four. The wheels or modules can be used in other quantities or configurations. A team purchases four and uses them in the most common configuration. Each part is treated separately for the purpose of CAW costing, since the purchased pieces can be used in various configurations.

- R13.** The CAW cost of each non-KOP item must be calculated based on the unit fair market value for the material and/or labor, except for labor provided by Team members (including sponsor employees who are members of the team), members of other Teams, event provided Machine Shops and shipping.

Example 1: A Team orders a custom bracket made by a company to the Team's specification. The company's material cost and normally charged labor rate apply.

Example 2: A Team receives a donated sensor. The company would normally sell this item for \$52 USD, which is therefore its fair market value.

Example 3: Special price discounts from National Instruments and other *FIRST* Suppliers are being offered to Teams. The discounted purchase price of items from these sources may be used in the additional parts accounting calculations.

Example 4: A Team purchases steel bar stock for \$10 USD and has it machined by a local machine shop. The machine shop is not considered a team Sponsor, but donates two (2) hours of expended labor anyway. The Team must include the estimated normal cost of the labor as if it were paid to the machine shop, and add it to the \$10 USD.

Example 5: A Team purchases steel bar stock for \$10 USD and has it machined by a local machine shop that is a recognized Sponsor of the Team. If the machinists are considered members of the Team, their labor costs do not apply. The total applicable cost for the part would be \$10 USD.

It is in the best interests of the Teams and *FIRST* to form relationships with as many organizations as possible. Teams are encouraged to be expansive in recruiting and including organizations in their team, as that exposes more people and organizations to *FIRST*. Recognizing supporting companies as Sponsors of, and members in, the Team is encouraged, even if the involvement of the Sponsor is solely through the donation of fabrication labor.

Example 6: A Team purchases steel bar stock for \$10 USD and has it machined by another Team. The total applicable cost for the part would be \$10 USD.

Example 7: A Team purchases a 4 ft. by 4 ft. (~122 cm by 122 cm) sheet of aluminum, but only uses a piece 10 in. by 10 in. (~25 cm by 25 cm) on their ROBOT. The Team identifies a source that sells aluminum sheet in 1 by 1 ft. pieces. The Team may cost their part on the basis of a 1 by 1 ft. piece, even though they cut the piece from a larger bulk purchase. They do not have to account for the entire 4 by 4 ft. bulk purchase item.

R14. Physical ROBOT elements created before Kickoff are not permitted. Exceptions are:

- A.** OPERATOR CONSOLE,
- B.** BUMPERS (a protective assembly designed to attach to the exterior of the ROBOT and constructed as specified in [Section 8.5 Bumper Rules](#)),
- C.** battery assemblies per R05-B,
- D.** FABRICATED ITEMS consisting of one COTS electrical device (e.g. a motor or motor controller) and attached components associated with any of the following modifications:
 - i.** Wires modified to facilitate connection to a ROBOT (including removal of existing connectors)
 - ii.** Connectors and any materials to secure and insulate those connectors added
 - iii.** Motor shafts modified and/or gears, pulleys, or sprockets added

Please note that this means that FABRICATED ITEMS from ROBOTS entered in previous *FIRST* competitions may not be used on ROBOTS in the 2018 *FIRST*® Robotics Competition (other than those allowed per R14-B through R14-D). Before the formal start of the Build Season, Teams are encouraged to think as much as they please about their ROBOTS. They may develop prototypes, create proof-of-concept models, and conduct design exercises. Teams may gather all the raw stock materials and COTS COMPONENTS they want.

Example 1: A Team designs and builds a two-speed shifting transmission during the fall as a training exercise. After Kickoff, they utilize all the design principles they learned in the fall to design their ROBOT. To optimize the transmission design for their ROBOT, they improve the transmission gear ratios and reduce the size, and build two new transmissions, and place them on the ROBOT. All parts of this process are permitted activities.

Example 2: A Team re-uses a 2018-legal motor from a previous ROBOT which has had connectors added to the wires. This is permitted, per exception D, because the motor is a COTS electrical COMPONENT.



- R15.** Software and mechanical/electrical designs created before Kickoff are only permitted if the source files (complete information sufficient to produce the design) are available publicly prior to Kickoff.

Example 1: A Team realizes that the transmission designed and built in the fall perfectly fits their need for a transmission to drive the ROBOT arm. They build an exact copy of the transmission from the original design plans, and bolt it to the ROBOT. This would be prohibited, as the transmission – although made during the competition season – was built from detailed designs developed prior to Kickoff.

Example 2: A Team developed an omni-directional drive system for the 2011 competition. Over the summer of 2011 they refined and improved the control software (written in C++) to add more precision and capabilities. They decided to use a similar system for the 2018 competition. They copied large sections of unmodified code over into the control software of the new ROBOT (also written in C++). This would be a violation of the schedule constraint, and would not be allowed.

Example 3: The same Team decides to use LabVIEW as their software environment for 2018. Following Kickoff, they use the previously-developed C++ code as a reference for the algorithms and calculations required to implement their omni-directional control solution. Because they developed new LabVIEW code as they ported over their algorithms, this would be permitted.

Example 4: A different Team develops a similar solution during the fall, and plans to use the developed software on their competition ROBOT. After completing the software, they post it in a generally accessible public forum and make the code available to all Teams. Because they have made their software publicly available before Kickoff, they can use it on their ROBOT.

Example 5: A Team develops a transmission during the fall. After completing the project, they publish the CAD files on a generally accessible public forum and make them available to all Teams. Because they have made the design publicly available before Kickoff, they can use the design to create an identical transmission, fabricated after Kickoff, for use on their 2018 ROBOT.

- R16.** All ROBOT elements (including items intended for use during the competition in alternative configurations of the ROBOT), with the exception of the WITHHOLDING ALLOWANCE per R22, BUMPERS, and COTS items, must be bagged and sealed, by 04:59 UTC on Stop Build Day, Wednesday, February 21, 2018.

PLEASE NOTE: THIS TIME IS DICTATED IN UTC (UNIVERSAL COORDINATED TIME). YOU WILL NEED TO CONVERT TO YOUR LOCAL TIMEZONE. THIS WILL RESULT IN A TIME ON THE PREVIOUS DAY (TUESDAY, FEBRUARY 20, 2018) FOR MANY TIMEZONES.

To bag your ROBOT:

- Locate the “Bag and Tag” kit from your Kickoff Kit which contains two plastic bags large enough to contain your ROBOT and at least ten tags with individual serial numbers.
- Set the bag on the floor, leaving room for the ROBOT in the center.

- Place the ROBOT in the center of the bag and pull the bag up around the ROBOT. Be careful not to catch the bag on the corners or sharp edges.
- Tightly seal the bag with your next numbered tag.
- Complete the ROBOT Lock-up Form to verify the date and time that the bag was sealed. The ROBOT Lock-up Form must be signed by an adult, 18 years old or older, who is not a student on the team. This form must be brought with you to all events.

R17. For convenience, Teams may disassemble their ROBOT and use up to three (3) bags to “Bag and Tag” the pieces. Each bag must have its own numbered tag and entry on the ROBOT Lock-up Form.

Note: The KOP only contains two (2) bags. Teams wishing to use three (3) bags must acquire the third bag themselves.

When transporting their ROBOT, Teams may use any transportation method they wish (at their own risk and expense), as long as the ROBOT remains sealed in the bag.

R18. If you are attending another event, such as a *FIRST* Championship or another Regional or District event, you must re-seal your ROBOT in the bag with a new tag and enter the new tag number on the ROBOT Lock-up Form prior to leaving the event.

R19. Teams must stay “hands-off” their bagged ROBOT elements during the following time periods:

- between Stop Build Day and their first event,
- during the period(s) between their events, and
- outside of Pit hours while attending events.

Modifying parts at night offsite (e.g. pits have closed and you bring a MECHANISM back to the hotel to fix it) is a violation of R19-C.

Additional time is allowed as follows:

- After Kickoff, there are no restrictions on when software may be developed.
- On days a team is not attending an event, they may continue development of any items permitted per R22, including items listed as exempt from R22, but must do so without interfacing with the ROBOT.
- ROBOTS may be unbagged for unofficial pre-inspection, with a certified 2018 LRI present. No work on or operation of the ROBOT is permitted beyond what is necessary to emulate the Inspection process. The purpose of this unofficial pre-inspection is to identify, in advance, potential issues with the ROBOT that may be found during the official inspection that takes place at the event. The ROBOT Lock-up Form must be used to track the unbagging and rebagging of the ROBOT during this period. In the “Explanation” column of the form, enter “LRI Pre-Inspection.”
- ROBOTS may be unbagged and operated briefly after “Stop Build Day” for brief display purposes only, or for any other purpose that could be reasonably considered ‘display only’ provided the following requirements are met:
 - The ROBOT Lock-up Form must be used to track the unbagging and rebagging of the ROBOT during this period. In the “Explanation” column of the form, enter “Robot Display”.



- ii. No activity that could be considered “work on” or “practice with” the ROBOT is allowed.
- iii. Brief displays of robot functions, driving for example, are allowed, but not to the extent that they could be considered practice

The intent of this option is to allow Teams to briefly show off their ROBOT (e.g. to their community, sponsors, judges, or potential sponsors) after “Stop Build Day”. The intent is not to allow ‘exhibition matches’, or other similar activities, as this would be considered practice.

Unbagging a ROBOT and putting it on display for many hours (i.e., more than four (4)) at a time is not considered a “brief” display.

A good way to avoid turning a ROBOT display period in to a practice session is to have non-DRIVE TEAM members operate the ROBOT, and only for as short a time as necessary to show the ROBOT’S capabilities.

If you have any questions about the ROBOT Display option, please email frcparts@firstinspires.org.

- H. Teams attending 2-day events may access their ROBOTS using the ROBOT Access Period.

Teams attending 2-day events will not have as much time to work on their ROBOTS at events as Teams attending traditional 3-day Regional events. Due to this, teams are granted an additional “Robot Access Period” to un-bag their ROBOT between the “Stop Build Day” and their 2-day district events. 2-day events for the 2018 season include District Qualifier events for the following areas:

- *FIRST* Chesapeake District (DC, MD, VA)
- *FIRST* Israel District (IS)
- *FIRST* Mid-Atlantic District (DE, NJ, Eastern PA)
- *FIRST* North Carolina District (NC)
- *FIRST* in Michigan District (MI)
- Ontario District (ON)
- Indiana *FIRST* District (IN)
- NE *FIRST* District (CT, MA, ME, NH, RI, VT)
- Pacific Northwest (AK, OR, WA)
- Peachtree District (GA)

- R20. Teams permitted to use the ROBOT Access Period per R19-H may only unlock their ROBOT for a total of six (6) hours during the 7-day period preceding any 2-day event in which their Team will be competing with their ROBOT.

The six hours may be broken up in any way the team wishes, with the exception that no single access period may be shorter than two (2) hours.

The ROBOT must be locked up between sessions which must be documented on the ROBOT Lock-up Form.

- R21. If the ROBOT is accessed before the event, the unbagging must be noted on the ROBOT Lock-up form and the ROBOT must be rebagged. The ROBOT must remain sealed in the bag until:



- A. Your ROBOT Lock-up Form has been checked and approved by an Inspector and
- B. The pits have officially been opened for ROBOT work.

R22. At each Event, Teams may have access to a WITHHOLDING ALLOWANCE. The WITHHOLDING ALLOWANCE is a static set of FABRICATED ITEMS that shall not exceed 30 lbs. (~13 kg.), brought to an event (or ROBOT Access Period) in addition to the bagged items, to be used to repair and/or upgrade their ROBOT. With permission from another Team, Teams may also have access to FABRICATED ITEMS that are part of that other Team's WITHHOLDING ALLOWANCE to repair and/or upgrade their ROBOT. The WITHHOLDING ALLOWANCE may only be brought into the Venue when the Team initially loads in at the Event. Items made at an Event do not count towards this weight limit.

Teams should be prepared to show their WITHHOLDING ALLOWANCE items, and potentially have them weighed, during load-in.

This means teams may not store FABRICATED ITEMS outside the pits to be brought to the event at a later time. This set may be changed between events (i.e. a Team may leave a different set of items out of the bag and/or fabricate new items to bring to their next event) provided the total weight of FABRICATED ITEMS brought to the next event does not exceed thirty (30) lbs. (~13 kg.).

There is no restriction on the quantity of COTS items or items which do not meet the definitions of COTS or FABRICATED ITEMS (e.g. raw materials) that may be accessed by a Team at an Event.

For Teams attending 2-Day Events, these FABRICATED ITEMS may be used during the ROBOT Access Period and/or brought to the Event, but the total weight may not exceed 30 lbs. (~13 kg.) FABRICATED ITEMS constructed during the ROBOT Access Period and bagged with the ROBOT are exempt from this limit.

Items specified as exempt from R14 are also exempt from the WITHHOLDING ALLOWANCE limit.

Example 1: A team creates 10 lbs (~4 kg.) of FABRICATED ITEMS after Stop Build Day. During their first ROBOT Access Period before their first event, they install these items on the ROBOT and bag them with the ROBOT. The team may bring up to 20 lbs. (~9 kg.) of FABRICATED ITEMS (which may be items removed from the ROBOT before bagging at the end of the ROBOT Access Period) with them to the event.

Example 2: A team creates 30 lbs (~13 kg.) of FABRICATED ITEMS after Stop Build Day. During their first ROBOT Access Period before their first event, they install these items on the ROBOT and bag them with the ROBOT. The team may not bring any FABRICATED ITEMS (including any initially bagged on Stop Build Day and removed during the ROBOT Access Period) with them to the event.

8.5 BUMPER Rules

A BUMPER is a required assembly which attaches to the ROBOT frame. BUMPERS are important because they protect ROBOTS from damaging/being damaged by other ROBOTS and FIELD elements. Criteria used in writing these rules included the following:

- Minimize variety of BUMPERS so teams can expect consistency
- Minimize the amount of design challenge in creating BUMPERS
- Minimize cost of BUMPER materials



- Maximize use of relatively ubiquitous materials

R23. ROBOTS are required to use BUMPERS to protect all outside corners of the FRAME PERIMETER. For adequate protection, at least 6 in. (~16 cm) of BUMPER must be placed on each side of each outside corner (see Figure 8-2) and must extend to within $\frac{1}{4}$ in. of the FRAME PERIMETER corner. If a FRAME PERIMETER side is shorter than 6 in. (~16 cm), that entire side must be protected by BUMPER (see Figure 8-3). A round or circular FRAME PERIMETER, or segment of the FRAME PERIMETER, is considered to have an infinite number of corners, therefore the entire frame or frame segment must be completely protected by BUMPER(S).

The dimension defined in R23 is measured along the FRAME PERIMETER. The portion of the BUMPER that extends beyond the corner of the FRAME PERIMETER is not included in the 6 in. (~16 cm) requirement. See Figure 8-2 below.



Figure 8-2: BUMPER corner examples

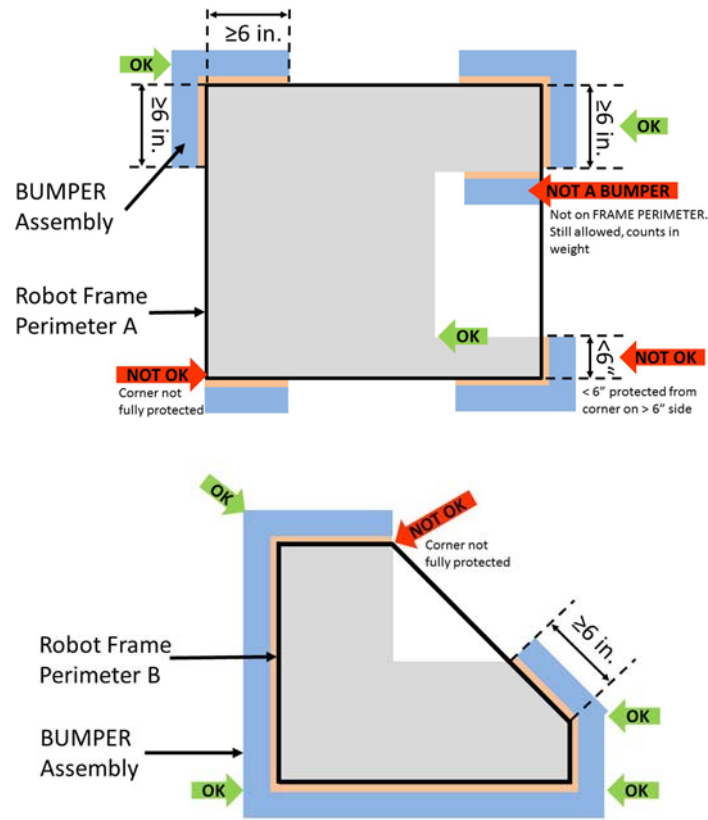
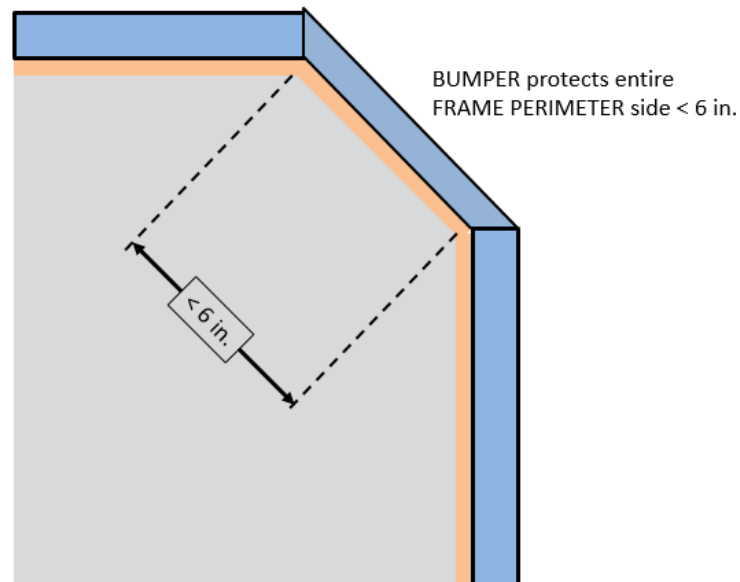


Figure 8-3: BUMPER around full side/corner.



- R24.** BUMPERS must be located entirely within the BUMPER ZONE, which is the volume contained between the floor and a virtual horizontal plane 7½ in. (~19 cm) above the floor in reference to the ROBOT standing normally on a flat floor. BUMPERS do not have to be parallel to the floor.

This measurement is intended to be made as if the ROBOT is resting on a flat floor (without changing the ROBOT configuration), not relative to the height of the ROBOT from the FIELD carpet. Examples include:

Example 1: A ROBOT that is at an angle while navigating the FIELD has its BUMPERS outside the BUMPER ZONE. If this ROBOT were virtually transposed onto a flat floor, and its BUMPERS are in the BUMPER ZONE, it meets the requirements of R24.

Example 2: A ROBOT deploys a MECHANISM which lifts the BUMPERS outside the BUMPER ZONE (when virtually transposed onto a flat floor). This violates R24.

- R25. BUMPERS must not be articulated (relative to the FRAME PERIMETER).
- R26. BUMPERS (the entire BUMPER, not just the cover) must be designed for quick and easy installation and removal to facilitate inspection and weighing.

As a guideline, BUMPERS should be able to be installed or removed by two (2) people in fewer than five (5) minutes.

- R27. Each ROBOT must be able to display Red or Blue BUMPERS to MATCH their ALLIANCE color, as assigned in the MATCH schedule distributed at the event (as described in [Section 10.1 MATCH Schedules](#)). BUMPER Markings visible when installed on the ROBOT, other than the following, are prohibited:
 - A. those required per R28,
 - B. hook-and-loop fastener or snap fasteners backed by the hard parts of the BUMPER, and
 - C. solid white *FIRST* logos between 4¼ in. (~13 cm) and 5¼ in. wide (~13 cm) (i.e. comparable to those distributed in the 2017 Kickoff Kit) and available in 2018 *FIRST* Choice.
- R28. Team numbers must be displayed and positioned on the BUMPERS such that an observer walking around the perimeter of the ROBOT can unambiguously tell the Team's number from any point of view and meet the following additional criteria:
 - A. consist of Arabic numerals at least 4 in. (~11 cm) high, at least ½ in. (~12.7 mm) in stroke width, and be either white in color or outlined in white with a minimum 1/16 in. (~1.6mm) outline

The ½ in. stroke width requirement applies to the majority of the stroke. Font elements less than ½ in. such as serifs, rounded edges, small hairlines or gaps, etc. are permitted as long as the majority of the stroke meets the sizing requirement and the numbers are unambiguous.

- B. must not wrap around sharp corners (less than 160 degrees) of the FRAME PERIMETER
- C. may not substitute logos or icons for numerals

There is no prohibition against splitting Team numbers onto different sections of BUMPER. The intent is that the Team's number is clearly visible and unambiguous so that Judges, REFEREES, Announcers, and other Teams can easily identify competing ROBOTS.

This marking is intended to display the Team number only, not to intentionally change the surface characteristics of the BUMPER.

Excessive material usage as part of any Team number marking will invite close scrutiny.

- R29.** Each set of BUMPERS (including any fasteners and/or structures that attach them to the ROBOT) must weigh no more than 20 lbs (~9 kg).

If a multi-part attachment system is utilized (e.g. interlocking brackets on the ROBOT and the BUMPER), then the elements permanently attached to the ROBOT will be considered part of the ROBOT, and the elements attached to the BUMPERS will be considered part of the BUMPER. Each element must satisfy all applicable rules for the relevant system.

- R30.** BUMPERS must be constructed as follows (see Figure 8-6):

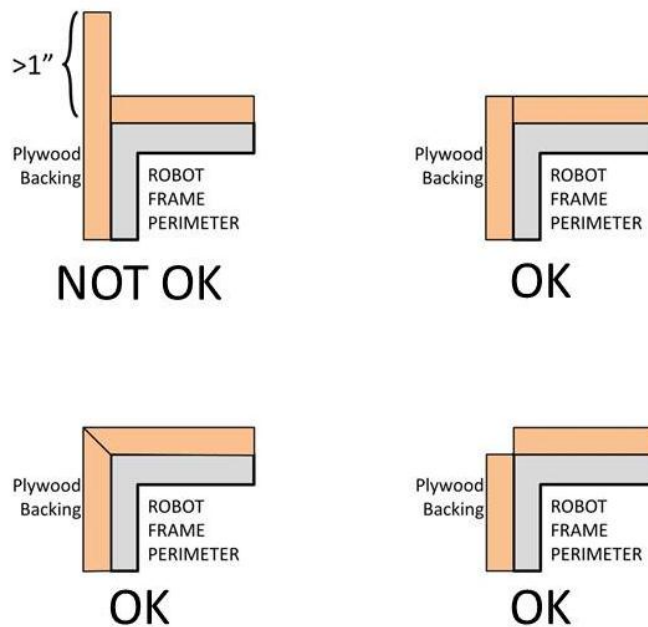
- A.** be backed by $\frac{3}{4}$ in. (nominal) thick (~19mm) by 5 in. \pm $\frac{1}{2}$ in. (~127 mm \pm 12.7 mm) tall plywood or solid, robust wood. Small clearance pockets and/or access holes in the plywood backing are permitted, as long as they do not significantly affect the structural integrity of the BUMPER.

Particle board or chipboard is not likely to survive the rigors of *FIRST* Robotics Competition gameplay and thus not compliant with R30-A.

Note: $\frac{3}{4}$ " plywood is now often marked according to the actual dimension ($\frac{23}{32}$ ") not the nominal size. Plywood sold as $\frac{23}{32}$ " meets the requirements of R30-A.

- B.** hard BUMPER parts allowed per R30-A, R30-E, R30-F, and R30-G must not extend more than 1 in. (~25 mm) beyond the FRAME PERIMETER with the exception of minor protrusions such as bolt heads, fastener ends, rivets, etc. (Figure 8-4 and Figure 8-6).

Figure 8-4: Hard Parts of BUMPER Corners



- C.** use a stacked pair of approximately 2½ in. (nominal) round, petal, or hex “pool noodles” (solid or hollow) as the BUMPER cushion material (see Figure 8-6). All pool noodles used in a BUMPER set (e.g. Red set of BUMPERS) may not be deformed

and must be the same diameter, cross-section, and density (e.g. all round hollow or all hex solid). Cushion material may extend up to 2½ in. (~63 mm) beyond the end of the plywood (see Figure 8-7). To assist in applying the fabric covering, soft fasteners may be used to attach the pool noodles to the wood backing, so long as the cross section in Figure 8-6 is not significantly altered (e.g. tape compressing the pool noodles).

All pool noodles used on a ROBOT must be the same in order to maintain the desired interaction between ROBOTS in the cases of BUMPER-to-BUMPER contact. BUMPERS containing pool noodles of vastly different construction may cause a “ramp” effect when interacting with other BUMPERS.

Noodle compression as a result of smoothing BUMPER fabric is not considered deformed. Any compression beyond that, e.g. for the purposes of flattening the noodle, is deformation and a violation of R30-C.

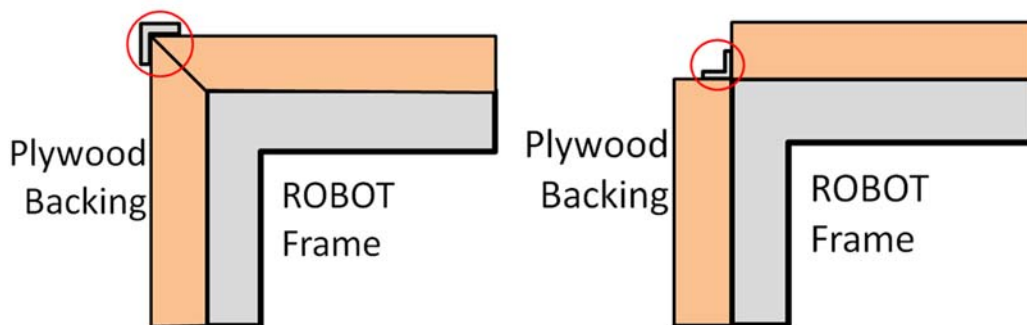
- D. be covered with a rugged, smooth cloth. (multiple layers of cloth and seams are permitted if needed to accommodate R27, provided the cross section in Figure 8-6 is not significantly altered).

Silk and bedding are not considered rugged cloths, however 1000D Cordura is. Tape (e.g. gaffer’s tape) matching the BUMPER color is allowed to patch small holes on a temporary basis.

The cloth must completely enclose all exterior surfaces of the wood and pool noodle material when the BUMPER is installed on the ROBOT. The fabric covering the BUMPERS must be solid in color.

- E. optionally use aluminum angle, as shown in Figure 8-6 or other fasteners (e.g. staples, screws, etc.) to clamp cloth.
- F. optionally use aluminum brackets (i.e. angle or sheet metal) to attach BUMPER segments to each other (see Figure 8-5).

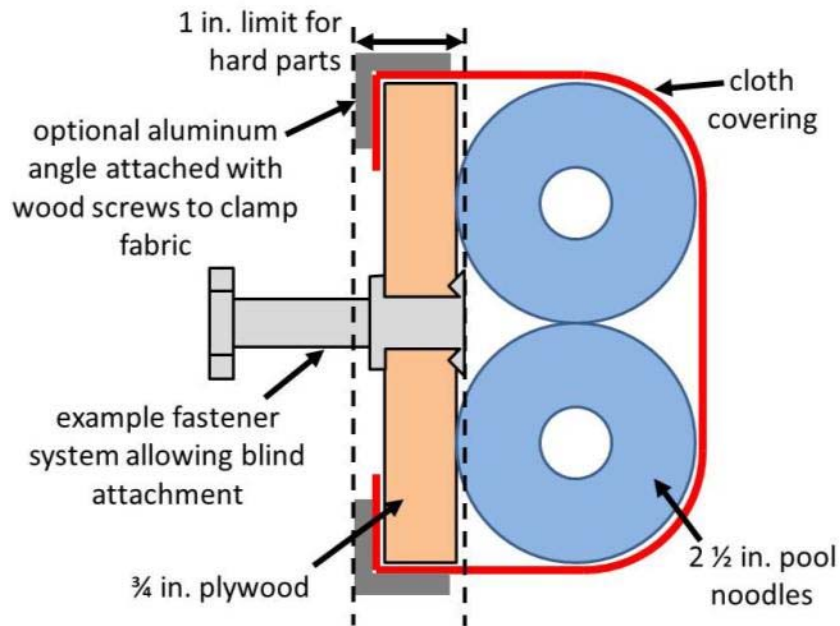
Figure 8-5: Hard Parts of BUMPER Corners



- G. must attach to the FRAME PERIMETER of the ROBOT with a rigid fastening system to form a tight, robust connection to the main structure/frame (e.g. not attached with hook-and-loop, tape, or tie-wraps). The attachment system must be designed to withstand vigorous game play. All removable fasteners (e.g. bolts, locking pins, pip-pins, etc.) will be considered part of the BUMPERS.

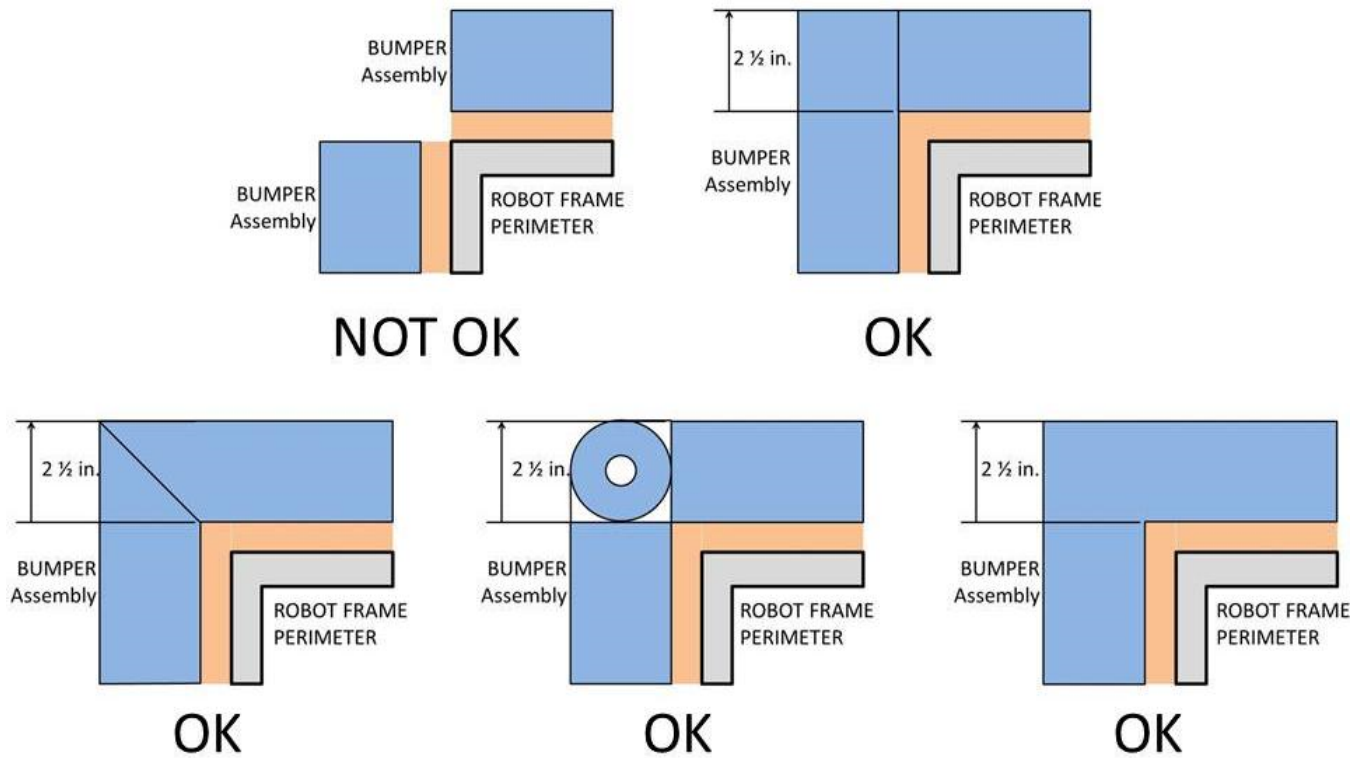


Figure 8-6: BUMPER Vertical Cross Section



R31. Corner joints between BUMPERS must be filled with pool noodle material. Examples of implementation are shown in Figure 8-7.

Figure 8-7: Soft Parts of BUMPER Corners



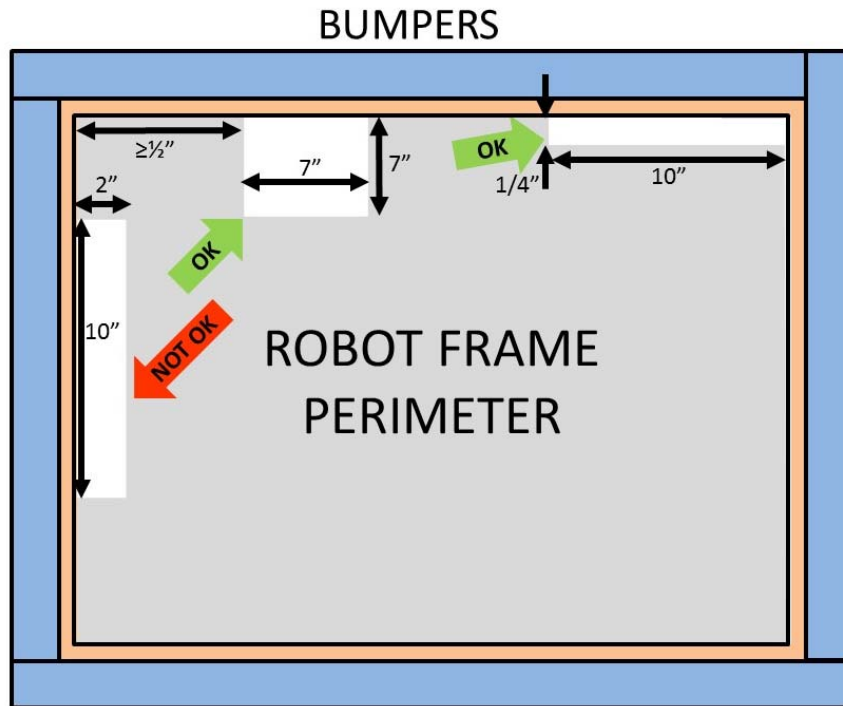
R32. BUMPERS must be supported by the structure/frame of the ROBOT (see Figure 8-8). To be considered supported, a minimum of 1/2 in. (~12.7 mm) at each end of each BUMPER wood



segment must be backed by the FRAME PERIMETER ($\leq 1/4$ in. gap). “Ends” exclude hard BUMPER parts which extend past the FRAME PERIMETER permitted by R30, part B. Additionally, any gap between the backing material and the frame:

- A. must not be greater than $1/4$ in. (~6 mm) deep, or
- B. not more than 8 in. (~20 cm) wide

Figure 8-8: BUMPER support examples



8.6 Motors & Actuators

- R33. The only motors and actuators permitted on 2018 ROBOTS include the following (in any quantity):

Table 8-1: Motor allowances

Motor Name	Part Numbers Available
CIM	FR801-001
	M4-R0062-12
	AM802-001A
	217-2000
	PM25R-44F-1005
	PM25R-45F-1004
	PM25R-45F-1003
	PMR25R-45F-1003
	PMR25R-44F-1005
	am-0255
West Coast Products RS775 Pro	217-4347
Banebots	M7-RS775-18
	RS775WC-8514
	M5 – RS550-12
	RS550VC-7527
	RS550
AndyMark 9015	am-0912
VEX BAG	217-3351
VEX mini-CIM	217-3371
AndyMark PG	am-2161 (alt. PN am-2765) am-2194 (alt. PN am-2766)
Select Automotive Motors (Window, Door, Windshield wiper, Seat, Throttle)	Various
Snow Blower Motor	am-2235
AndyMark NeveRest	am-3104
AndyMark RedLine Motor	am-3775
Nidec Dynamo BLDC Motor	am-3740
	DM3012-1063
Electrical solenoid actuators, no greater than 1 in. (nominal) stroke and rated electrical input power no greater than 10 watts (W) continuous duty at 12 volts (VDC)	
Hard drive motors or fans that are: included in any Kickoff Kit, distributed via FIRST Choice, part of a legal motor controller (including manufacturer provided accessories), or part of a legal COTS computing device	
Factory installed vibration and autofocus motors resident in COTS computing devices (e.g. rumble motor in a smartphone).	
PWM COTS servos with a retail cost < \$75.	
Motors integral to a COTS sensor (e.g. LIDAR, scanning sonar, etc.), provided the device is not modified except to facilitate mounting	

For servos, note that the roboRIO is limited to a max current output of 2.2A on the 6V rail (12.4W of electrical input power). Teams should make sure that their total servo power usage remains below this limit at all times.

Given the extensive amount of motors allowed on the ROBOT, Teams are encouraged to consider the total power available from the ROBOT

battery during the design and build of the ROBOT. Drawing large amounts of current from many motors at the same time could lead to drops in ROBOT battery voltage that may result in tripping the main breaker or trigger the brownout protection of the roboRIO. For more information about the roboRIO brownout protection and measuring current draw using the PDP, see [roboRIO Brownout and Understanding Current Draw](#).

- R34.** The integral mechanical and electrical system of any motor must not be modified. Motors, servos, and electric solenoids used on the ROBOT shall not be modified in any way, except as follows:
- A.** The mounting brackets and/or output shaft/interface may be modified to facilitate the physical connection of the motor to the ROBOT and actuated part.
 - B.** The electrical input leads may be trimmed to length as necessary and connectors or splices to additional wiring may be added.
 - C.** The locking pins on the window motors (P/N: 262100-3030 and 262100-3040) may be removed.
 - D.** The connector housings on window, door, windshield wiper or seat motors and Bosch motors (P/N: 6004 RA3 353-01) may be modified to facilitate lead connections.
 - E.** Servos may be modified as specified by the manufacturer (e.g. re-programming or modification for continuous rotation).
 - F.** The wiring harness of the Nidec Dynamo BLDC Motor may be modified [as documented by FIRST in the "Nidec Dynamo BLDC Motor with Controller" Screensteps article](#).

The intent of this rule is to allow teams to modify mounting tabs and the like, not to gain a weight reduction by potentially compromising the structural integrity of any motor. The integral mechanical and electrical system of the motor is not to be modified.

Note that for the previous KOP Window motors and the Bosch motor, the gearbox is considered integral to the motor, thus the motor may not be used without the gearbox.

- R35.** With the exception of servos, fans, or motors integral to sensors of COTS computing devices permitted in R33, each actuator must be controlled by a power regulating device. The only power regulating devices for actuators permitted on the ROBOT include:
- A.** Motor Controllers
 - i.** DMC 60 Motor Controller (P/N: 410-334-1)
 - ii.** Nidec Dynamo BLDC Motor with Controller to control integral actuator only (P/N 840205-000, am-3740)
 - iii.** Jaguar Motor Controller (P/N: MDL-BDC, MDL-BDC24, and 217-3367) connected to PWM only
 - iv.** SD540 Motor Controller (P/N: SD540x1, SD540x2, SD540x4, SD540Bx1, SD540Bx2, SD540Bx4, SD540C)
 - v.** Spark Motor Controller (P/N: REV-11-1200)
 - vi.** Talon Motor Controller (P/N: CTRE_Talon, CTRE_Talon_SR, and am-2195)
 - vii.** Talon SRX Motor Controller (P/N: 217-8080, am-2854, 14-838288)
 - viii.** Victor 884 Motor Controller (P/N: VICTOR-884-12/12)



- ix. Victor 888 Motor Controller (P/N: 217-2769)
- x. Victor SP Motor Controller (P/N: 217-9090, am-2855, 14-868380)
- xi. Victor SPX Motor Controller (P/N: 217-9191, 17-868388, am-3748)

B. Relay Modules

- i. Spike H-Bridge Relay (P/N: 217-0220 and SPIKE-RELAY-H)

C. Pneumatics controllers

- i. Pneumatics Control Module (P/N: am-2858, 217-4243)

R36. Each power regulating device may control electrical loads per Table 8-2. Unless otherwise noted, each power regulating device shall control one and only one electrical load.

Table 8-2: Power regulating device allotments

Electrical Load	Motor Controller	Relay Module	Pneumatics Controller
CIM AndyMark 9015 WCP RS775 Pro VEX BAG/MiniCIM Banebots AndyMark RedLine Motor	Yes	No	No
Automotive Window/Door/Windshield Wiper/Seat/Throttle Motors AndyMark PG Snow-Blower Motor NeverRest	Yes (up to 2 per controller)	Yes	No
Nidec Dynamo BLDC Motor with Controller	Yes (integrated controller only)	No	No
Compressor	No	Yes	Yes
Pneumatic Solenoid Valves	No	Yes ¹	Yes (1 per channel)
Electric Solenoids	No	Yes ¹	Yes (1 per channel)
CUSTOM CIRCUITS ²	Yes	Yes ¹	Yes (1 per channel)

¹ Multiple low-load, pneumatic solenoid valves, electric solenoids or CUSTOM CIRCUITS may be connected to a single relay module. This would allow one (1) relay module to drive multiple pneumatic actions or multiple CUSTOM CIRCUITS. No other electrical load can be connected to a relay module used in this manner.

² A CUSTOM CIRCUIT is any electrical COMPONENT of the ROBOT other than motors, pneumatic solenoids, roboRIO, PDP, PCM, VRM, RSL, 120A breaker, motor controllers, relay modules (per R35-B), wireless bridge, or batteries.

R37. Servos must be connected to, and only to, one of the following:

- A. PWM ports on the roboRIO
- B. PWM ports on a WCP Spartan Sensor Board (P/N: WCP-0045)

- C. REV Servo Power Module (P/N: REV-11-1144)

8.7 Power Distribution

- R38.** The only legal source of electrical energy for the ROBOT during the competition, the ROBOT battery, must be a non-spillable sealed lead acid (SLA) battery with the following specifications:
- A. Nominal voltage: 12V
 - B. Nominal capacity at 20-hour discharge rate: minimum 17Ah, maximum 18.2Ah
 - C. Shape: Rectangular
 - D. Nominal Dimensions: 7.1 in. x 3 in. x 6.6 in., +/- .1 in. for each dimension (~ 180 mm x 76mm x 168 mm, +/- 2.5 mm for each dimension)
 - E. Nominal weight: 11lbs. to 14.5 lbs. (~5 kg. to 6.5 kg.)
 - F. Terminals: Nut and bolt style

Examples of batteries which meet these criteria include:

- A. Energysys (P/N: NP18-12, NP18-12B, NP18-12BFR)
- B. MK Battery (P/N: ES17-12)
- C. Battery Mart (P/N: SLA-12V18)
- D. Sigma (P/N: SP12-18)
- E. Universal Battery (P/N: UB12180)
- F. Power Patrol (P/N: SLA1116)
- G. Werker Battery (P/N: WKA12-18NB)
- H. Power Sonic (P/N: PS-12180NB)
- I. Yuasa (P/N: NP18-12B)
- J. Panasonic (P/N: LC-RD-1217)
- K. Interstate Batteries (P/N: BSL1116)
- L. Duracell Ultra Battery (P/N: DURA12-18NB)

Teams should be aware that they may be asked to provide documentation of the specifications of any battery not listed above.

Batteries should be charged in accordance with manufacturer's specification. (Please see the [FIRST Safety Manual](#) for additional information.)

- R39.** COTS USB battery packs with a capacity of 100Wh or less (20000mAh at 5V) and 2.5 Amp max output per port, or batteries integral to and part of a COTS computing device or self-contained camera (e.g. laptop batteries, GoPro style camera, etc.) may be used to power COTS computing devices and any peripheral COTS input or output devices connected to the COTS computing device provided they are:
- A. securely fastened to the ROBOT.
 - B. connected only using unmodified COTS cables
 - C. charged according to manufacturer recommendations

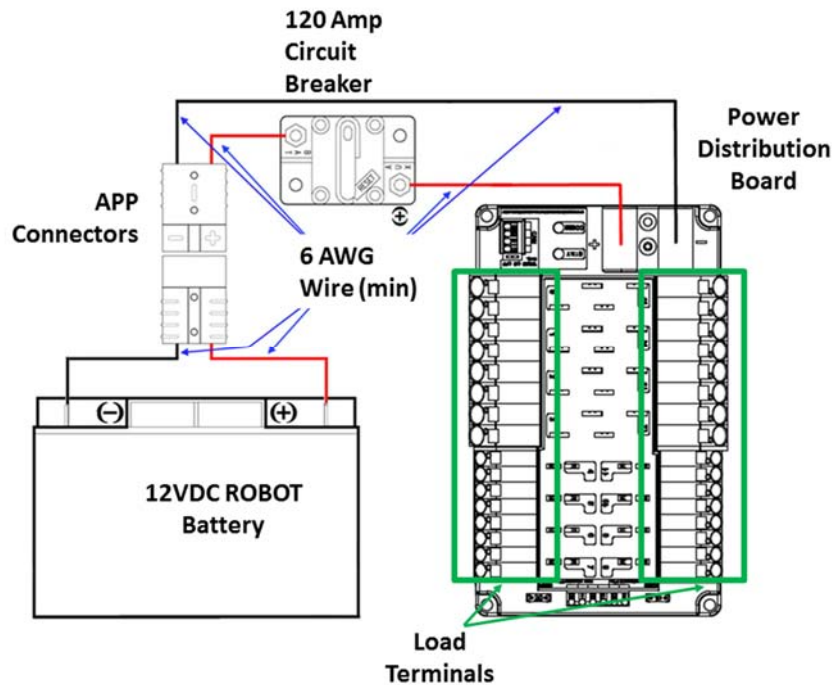


- R40.** Any battery charger used to charge a ROBOT battery must have the corresponding Anderson SB connector installed.
- R41.** Any battery charger used to charge a ROBOT battery may not be used such that it exceeds 6-Amp peak charge current.
- R42.** No batteries other than those allowed per R38 and R39 are allowed on the ROBOT, whether or not they are being used to supply power.

This means teams may not use additional batteries as extra weight on their ROBOTS, for example.

- R43.** The ROBOT battery must be secured such that it will not dislodge during vigorous ROBOT interaction including if the ROBOT is turned over or placed in any arbitrary orientation.
- R44.** Each electrical terminal on the ROBOT battery, main breaker, and their connections (lugs, stripped wire ends, etc.) to the wire must be fully insulated at all times.
- R45.** Non-electrical sources of energy used by the ROBOT, (i.e., stored at the start of a MATCH), shall come only from the following sources:
 - A.** compressed air stored in the pneumatic system that has been charged in compliance with R85 and R87,
 - B.** a change in the altitude of the ROBOT center of gravity,
 - C.** storage achieved by deformation of ROBOT parts,
 - D.** closed-loop COTS pneumatic (gas) shocks, and
 - E.** air-filled (pneumatic) wheels.
- R46.** The one (1) ROBOT battery, a single pair of Anderson Power Products (or APP) 2-pole SB type connectors, the one (1) main 120-amp (120A) surface mount circuit breaker (Cooper Bussman P/N: CB185-120 or CB185F-120), and the one (1) CTR Electronics Power Distribution Panel (PDP, P/N: am-2856, 217-4244, 14-806880) shall be connected with 6 AWG (7 SWG or 16 mm²) copper wire or larger, with no additional devices or modifications, as shown in Figure 8-9.

Figure 8-9: Electrical connection diagram



“SB type” refers to SB type only (e.g. SB-50, SB-120, etc.), not SBS or any other part type beginning with SB. All batteries supplied by *FIRST* (such as Spare Parts and international batteries) will have a Red or Pink SB50 connector installed which may not be removed.

The pink connectors included in the 2018 KOP mate with the Red SB50 connector.

- R47. All circuits, with the exceptions of those listed in R52 and R54, must connect to, and have power sourced solely by, a single protected 12VDC WAGO connector pair (i.e. the Load Terminals, as shown in Figure 8-9) of the one (1) CTR Electronics Power Distribution Panel, not the M6 cap screws.
- R48. All wiring and electrical devices, including all Control System COMPONENTS, shall be electrically isolated from the ROBOT frame. The ROBOT frame must not be used to carry electrical current.

R48 is checked by observing a $>3k\Omega$ resistance between either the (+) or (-) post within the APP connector that is attached to the PDP and any point on the ROBOT.

The Victor-SP and Talon-SRX motor controller cases are electrically isolated. They may be mounted directly to ROBOT frame COMPONENTS.

Note that some cameras, decorative lights and sensors (e.g. the Axis 206 camera, some encoders, some IR sensors, etc.) have grounded enclosures. These devices must be electrically isolated from the ROBOT frame to ensure compliance with R48.

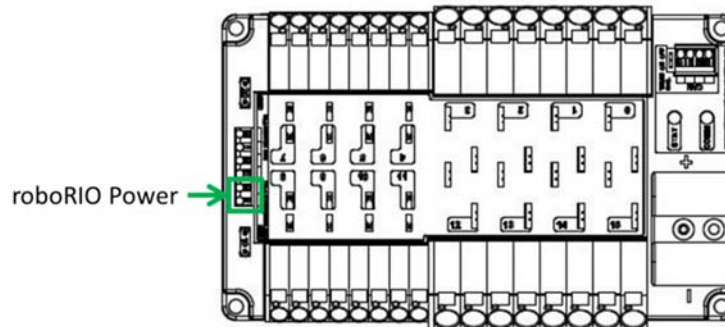
- R49. The 120A circuit breaker must be quickly and safely accessible from the exterior of the ROBOT. This is the only 120A circuit breaker allowed on the ROBOT.

Examples considered not “quickly and safely accessible” include breakers covered by an access panel or door, or mounted on, underneath or immediately adjacent to moving components.

It is strongly recommended that the 120A circuit breaker location be clearly and obviously labeled so it can be easily found by FIELD STAFF during a MATCH.

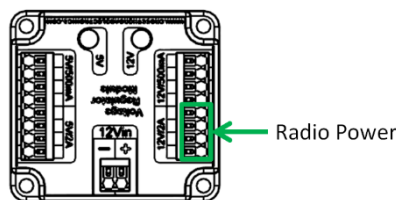
- R50.** The PDP, associated wiring, and all circuit breakers must be easily visible for Inspection.
- R51.** Any active electrical item that is not an actuator (specified in R33) or core Control System item (specified in R72) is considered a CUSTOM CIRCUIT. CUSTOM CIRCUITS shall not produce voltages exceeding 24V.
- R52.** The roboRIO power input must be connected to the dedicated supply terminals on the PDP shown in Figure 8-10. No other electrical load shall be connected to these terminals.

Figure 8-10: roboRIO power source



- R53.** The Wireless Bridge (Radio) power must be supplied directly by the 12V 2A output of a CTR Electronics Voltage Regulator Module (VRM) (P/N: am-2857, 217-4245) and must be the only load connected to those terminals.

Figure 8-11: Radio power source



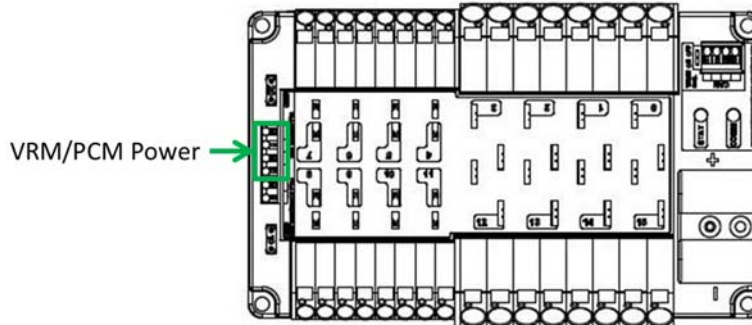
Note that this wiring is different from the wiring for the radio used in 2015, but is identical to the wiring from 2016 and 2017. When using a 2015 VRM with the OM5P-AN or OM5P-AC radio, the radio should be connected as described above, not to the terminals labeled “Radio”.

Note that this prohibits using any active POE Injector device to power the radio, but does not prohibit using any PASSIVE CONDUCTORS to inject the VRM power into an Ethernet cable plugged into the radio port labeled “18-24v POE”.

- R54.** The VRM supplying power to the Wireless Bridge per R53 must be connected to the designated supply terminals at the end of the PDP, and not the main WAGO connectors along the sides of

the PDP as shown in Figure 8-12. With the exception of a single CTR Electronics Pneumatics Control Module (PCM, P/N: am-2858), no other electrical load shall be connected to these PDP terminals.

Figure 8-12: VRM and PCM power source



Please reference [Wiring the FRC Control System](#) for Wireless Bridge wiring information.

R55. Only one wire shall be connected to each WAGO connector on the PDP.

If multi-point distribution of circuit power is needed (e.g. to provide power to multiple PCMs and/or VRMs from one 20A circuit), then all incoming wires may be appropriately spliced into the main lead (e.g. using an insulated terminal block, crimped splice or soldered wire splice), and the single main lead inserted into the WAGO connector to power the circuit.

R56. The only circuit breakers permitted for use in the PDP are:

- A. Snap Action VB3-A Series, terminal style F57
- B. Snap Action MX5-A or MX5-L Series, 40A rating or lower

R57. The fuses in the PDP shall only be replaced with functionally identical fuses (mini automotive blade fuses with values matching those printed on the PDP)

R58. Each branch circuit must be protected by one and only one circuit breaker on the PDP per Table 8-3. No other electrical load can be connected to the breaker supplying this circuit.

Table 8-3: Branch circuit protection requirements

Branch Circuit	Circuit Breaker Value	Quantity Allowed Per Breaker
Motor Controller	Up to 40A	1
CUSTOM CIRCUIT	Up to 40A	1
Fans permitted per Table 8-1 and not already part of COTS computing devices	Up to 20A	No limit
Relay Module	Up to 20A	1
PCM – with compressor	20A	1
Additional VRM (non-radio)/Additional PCM (non-compressor)	20A	3 total

R58 does not prohibit the use of smaller value breakers in the PDP or any fuses or breakers within CUSTOM CIRCUITS for additional protection.

- R59.** All circuits shall be wired with appropriately sized insulated copper wire (SIGNAL LEVEL cables don't have to be copper):

Table 8-4: Wire sizes

Application	Minimum Wire Size
31 – 40A protected circuit	12 AWG (13 SWG or 4 mm ²)
21 – 30A protected circuit	14 AWG (16 SWG or 2.5 mm ²)
6 – 20A protected circuit	18 AWG
Between the PDP dedicated terminals and the VRM or PCM Compressor outputs from the PCM	(19 SWG or 1 mm ²)
Between the PDP and the roboRIO ≤5A protected circuit	22 AWG (22 SWG or 0.5 mm ²)
VRM 2A circuits	24 AWG (24 SWG or .25mm ²)
roboRIO PWM port outputs	26 AWG (27 SWG or 0.14 mm ²)
SIGNAL LEVEL circuits (i.e. circuits which draw ≤1A continuous and have a source incapable of delivering >1A, including but not limited to roboRIO non-PWM outputs, CAN signals, PCM Solenoid outputs, VRM 500mA outputs and Arduino outputs)	28 AWG (29 SWG or .08 mm ²)

Wires that are recommended by the device manufacturer or originally attached to legal devices are considered part of the device and by default legal. Such wires are exempt from R59.

- R60.** Branch circuits may include intermediate elements such as COTS connectors, splices, COTS flexible/rolling/sliding contacts, and COTS slip rings, as long as the entire electrical pathway is via appropriately gauged/rated elements.
- R61.** All non-SIGNAL LEVEL wiring with a constant polarity (i.e., except for outputs of relay modules, motor controllers, or sensors) shall be color-coded along their entire length from the manufacturer as follows:
- A.** Red, yellow, white, brown, or black-with-stripe on the positive (e.g. +24VDC, +12VDC, +5VDC, etc.) connections
 - B.** Black or blue for the common or negative side (-) of the connections.

Wires that are originally attached to legal devices are considered part of the device and by default legal. Ethernet cable used in POE cables may use a different color standard. Such wires are exempt from R61.

- R62.** CUSTOM CIRCUITS shall not directly alter the power pathways between the ROBOT battery, PDP, motor controllers, relays (per R35-B), motors and actuators (per R33), pneumatic solenoid valves, or other elements of the ROBOT control system (items explicitly mentioned in R72). Custom high impedance voltage monitoring or low impedance current monitoring circuitry connected to the ROBOT'S electrical system is acceptable, if the effect on the ROBOT outputs is inconsequential.

A noise filter may be wired across motor leads or PWM leads. Such filters will not be considered CUSTOM CIRCUITS and will not be considered a violation of R62 or R79.

Acceptable signal filters must be fully insulated and must be one of the following:

- A one microfarad (1 μ F) or less, non-polarized, capacitor may be applied across the power leads of any motor on your ROBOT (as close to the actual motor leads as reasonably possible).
- A resistor may be used as a shunt load for the PWM control signal feeding a servo.

8.8 Control, Command & Signals System

R63. ROBOTS must be controlled via one (1) programmable National Instruments roboRIO (P/N: am3000), with image version FRC_2018_v16 or later.

There are no rules that prohibit co-processors, provided commands originate from the roboRIO to configure, enable, and specify all operating points for all power regulating devices. This includes motor controllers legally wired to the CAN-bus.

R64. One (1) OpenMesh Wireless Bridge (P/N: OM5P-AN or OM5P-AC), that has been configured with the appropriate encryption key for your team number at each event, is the only permitted device for communicating to and from the ROBOT during the MATCH.

R65. The roboRIO Ethernet port must be connected to the Wireless Bridge port labeled “18-24 vPOE,” closest to the power connector (either directly, via a network switch, or via a CAT5 Ethernet pigtail).

Note: Placing a switch between the roboRIO and radio may impede the ability for FIELD STAFF to troubleshoot roboRIO connection issues on the FIELD. Teams may be asked to try directly connecting from the radio to roboRIO as part of troubleshooting efforts.

R66. Communication between the ROBOT and the OPERATOR CONSOLE is restricted as follows:

A. Network Ports:

- ii.** HTTP 80: Camera connected via switch on the ROBOT, bi-directional
- iii.** HTTP 443: Camera connected via switch on the ROBOT, bi-directional
- iv.** UDP/TCP 554: Real-Time Streaming Protocol for h.264 camera streaming, bi-directional
- v.** UDP 1130: Dashboard-to-ROBOT control data, uni-directional
- vi.** UDP 1140: ROBOT-to-Dashboard status data, uni-directional
- vii.** UDP/TCP 1180-1190: Camera data from the roboRIO to the Driver Station (DS) when the camera is connected the roboRIO via USB, bi-directional.
- viii.** TCP 1735: SmartDashboard, bi-directional
- ix.** UDP/TCP 5800-5810: Team Use, bi-directional

Teams may use these ports as they wish if they do not employ them as outlined above (i.e. TCP 1180 can be used to pass data back and forth between the ROBOT and the DS if the Team chooses not to use the camera on USB).

B. Bandwidth: no more than 7 Mbits/second.

Note that the 7 Mbit limit will be strictly enforced by the Wireless Bridge.

The [FMS Whitepaper](#) has more details on how to check and optimize bandwidth usage.

While *FIRST*® makes every effort to provide a wireless environment that allows teams access to a full 7 Mbits/second data rate (with about 100 Kbit used for ROBOT control and status), at some events wireless conditions may not accommodate this.

- R67.** The roboRIO, Driver Station software, and Wireless Bridge must be configured to correspond to the correct Team number, per the procedures defined in [Getting Started with the 2018 Control System](#).
- R68.** All signals must originate from the OPERATOR CONSOLE and be transmitted to the ROBOT via the ARCADE Ethernet network.
- R69.** No form of wireless communication shall be used to communicate to, from, or within the ROBOT, except those required per R64 and R68.

Devices that employ signals in the visual spectrum (e.g. cameras) and non-RF sensors that don't receive human-originated commands (e.g. "beam break" sensors or IR sensors on the ROBOT used to detect FIELD elements) aren't wireless communication devices and thus R69 doesn't apply.

- R70.** The Wireless Bridge must be mounted on the ROBOT such that the diagnostic lights are visible to ARCADE personnel.

Teams are encouraged to mount the wireless bridge away from noise generating devices such as motors, PCM(s), and VRM(s).

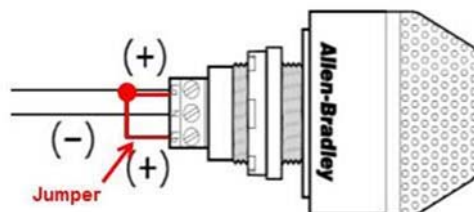
- R71.** ROBOTS must use at least one (1), but no more than two (2), diagnostic Robot Signal Lights (RSL) (P/N: 855PB-B12ME522).

Any RSL must be:

- A.** mounted on the ROBOT such that it is easily visible while standing three 3 ft. (~ 100 cm) in front of the ROBOT,
- B.** connected to the "RSL" supply terminals on the roboRIO,
- C.** wired for solid light operation, by placing a jumper between the "La" and "Lb" terminals on the light per Figure 8-13.

Please see [Wiring the 2018 FRC Control System](#) for connection details.

Figure 8-13: RSL jumper wiring





- R72.** The Driver Station software, roboRIO, Power Distribution Panel, Pneumatics Control Modules, Voltage Regulator Modules, RSL, 120A breaker, motor controllers, relay modules (per R35-B), Wireless Bridge, and batteries shall not be tampered with, modified, or adjusted in any way (tampering includes drilling, cutting, machining, rewiring, disassembling, painting, etc.), with the following exceptions:

Please note that the Driver Station application is a separate application from the Dashboard. The Driver Station software may not be modified, while teams are expected to customize their Dashboard code.

- A.** User programmable code in the roboRIO may be customized.
- B.** Motor controllers may be calibrated as described in owner's manuals.
- C.** Fans may be attached to motor controllers and may be powered from the power input terminals.
- D.** If powering the compressor, the fuse on a Spike H-Bridge Relay may be replaced with a 20A Snap-Action circuit breaker.
- E.** Wires, cables, and signal lines may be connected via the standard connection points provided on the devices.
- F.** Fasteners (including adhesives) may be used to attach the device to the OPERATOR CONSOLE or ROBOT or to secure cables to the device.
- G.** Thermal interface material may be used to improve heat conduction.
- H.** Labeling may be applied to indicate device purpose, connectivity, functional performance, etc.
- I.** Jumpers may be changed from their default location.
- J.** Limit switch jumpers may be removed from a Jaguar motor controller and a custom limit switch circuit may be substituted.
- K.** Device firmware may be updated with manufacturer supplied firmware.
- L.** Integral wires on the Victor SP, Victor SPX, or Talon SRX may be cut, stripped, and/or connectorized.
- M.** Devices may be repaired, provided the performance and specifications of the device after the repair are identical to those before the repair.
- N.** The cover may be removed from the Talon SRX data port.

Please note that while repairs are permitted, the allowance is independent of any manufacturer's warranty. Teams make repairs at their own risk and should assume that any warranty or RMA options are forfeited. Be aware that diagnosing and repairing COMPONENTS such as these can be difficult.

- R73.** Neither 12VDC power nor relay module or motor controller outputs shall be directly connected to the roboRIO (with the exception of the designated 12VDC input).
- R74.** Every relay module (per R35-B), servo controller, and PWM motor controller shall be connected to a corresponding port (relays to Relay ports, servo controllers and PWM controllers to PWM ports) on the roboRIO (either directly or through a WCP Spartan Sensor Board) or via a legal MXP connection (per R75). They shall not be controlled by signals from any other source, with the exception of the Nidec Dynamo motor controller which must also be connected to the roboRIO Digital I/O.



R75. If a motor is controlled via the MXP, its power regulating device must be connected by one of the following methods:

- A.** directly to any PWM pins,
- B.** via a network of PASSIVE CONDUCTORS used to extend the PWM pins, or
- C.** via one approved ACTIVE DEVICE:
 - i.** Kauai Labs navX MXP
 - ii.** RCAL MXP Daughterboard
 - iii.** REV Robotics RIOduino
 - iv.** REV Robotics Digit Board
 - v.** West Coast Products Spartan Sensor Board
 - vi.** Huskie Robotics HUSKIE 2.0 Board

A PASSIVE CONDUCTOR is any device or circuit whose capability is limited to the conduction and/or static regulation of the electrical energy applied to it (e.g. wire, splices, connectors, printed wiring board, etc.).

An ACTIVE DEVICE is any device capable of dynamically controlling and/or converting a source of electrical energy by the application of external electrical stimulus.

The “network of PASSIVE CONDUCTORS” only applies to the pins being used for PWM output to motors or servos. This means that connecting an ACTIVE DEVICE, such as a sensor to one MXP pin does not prevent other MXP pins from being used in accordance with R75-B.

R76. Each CAN motor controller must be controlled with signal inputs sourced from the roboRIO and passed via either a PWM (wired per R74) or CAN-bus (either directly or daisy-chained via another CAN-bus device) signal, but both shall not be wired simultaneously on the same device.

As long as the CAN bus is wired legally so that the heartbeat from the roboRIO is maintained, all closed loop control features of the CAN motor controller may be used. (That is, commands originating from the roboRIO to configure, enable, and specify an operating point for all CAN motor controller closed loop modes fit the intent of R63.

R77. Each PCM must be controlled with signal inputs sourced from the roboRIO and passed via a CAN-bus connection from the roboRIO (either directly or daisy-chained via another CAN-bus device).

R78. The PDP CAN interface must be connected to the CAN-bus on the roboRIO (either directly or daisy-chained via another CAN-bus device).

For documentation on how to wire the CAN-bus connections of the PDP see [Wiring the 2018 FRC Control System](#).

R79. The CAN-bus must be connected to the roboRIO CAN port.

- A.** Additional switches, sensor modules, CUSTOM CIRCUITS, third-party modules, etc. may also be placed on the CAN-bus.
- B.** No device that interferes with, alters, or blocks communications among the roboRIO and the PDP, PCMs, and/or CAN Motor Controllers on the bus will be permitted.

Only one wire should be inserted into each Weidmuller CAN connector terminal. For documentation on how to wire the CAN-bus connections of the roboRIO, PCM, PDP and CAN motor controllers, see [Wiring the FRC Control System](#).

8.9 Pneumatic System

R80. To satisfy multiple constraints associated with safety, consistency, Inspection, and constructive innovation, no pneumatic parts other than those explicitly permitted in [Section 8.9 Pneumatic System](#) shall be used on the ROBOT.

R81. All pneumatic items must be COTS pneumatic devices and either:

- A. rated by their manufacturers for pressure of at least 125psi (~862 kPa), or
- B. installed downstream of the primary relieving regulator (see R88), and rated for pressure of at least 70psi (~483 kPa)

Any pressure specification such as “working,” “operating,” “maximum,” etc. may be used to satisfy the requirements of R81.

It is recommended that all pneumatic items be rated by their manufacturers for a working pressure of at least 60 psi (~414 kPa).

R82. All pneumatic COMPONENTS must be used in their original, unaltered condition. Exceptions are as follows:

- A. tubing may be cut,
- B. wiring for pneumatic devices may be modified to interface with the control system,
- C. assembling and connecting pneumatic COMPONENTS using the pre-existing threads, mounting brackets, quick-connect fittings, etc.,
- D. removing the mounting pin from a pneumatic cylinder, provided the cylinder itself is not modified,
- E. labeling applied to indicate device purpose, connectivity, functional performance, etc.

Do not, for example, paint, file, machine, or abrasively remove any part of a pneumatic COMPONENT – this would cause the part to become a prohibited item. Consider pneumatic COMPONENTS sacred.

R83. The only pneumatic system items permitted on ROBOTS include the items listed below.

- A. Items available in the KOP (except as noted in K),
- B. Pneumatic pressure vent plug valves functionally equivalent to those provided in the KOP,

Parker valves PV609-2 or MV709-2 are recommended.

- C. Pressure relief valves functionally equivalent to those provided in the KOP,

Norgren 16-004-011, 16-004-003 or McMaster-Carr 48435K714 recommended.

To be considered functionally equivalent the valve must be preset or adjustable to 125 psi (~862 kPa) and capable of relieving at least 1 scfm (~472 cm³/s).

- D. Solenoid valves with a maximum $\frac{1}{8}$ in. (nominal, ~6 mm) NPT, BSPP, or BSPT port diameter,
- E. Additional pneumatic tubing, with a maximum $\frac{1}{4}$ in. (nominal, ~6 mm) outside diameter,
- F. Pressure transducers, pressure gauges, passive flow control valves (specifically “needle valve”), manifolds, and connecting fittings (including COTS pneumatic U-tubes),
- G. Check and quick exhaust valves, provided that the requirements of R95 are still met.
- H. Shutoff valves which relieve downstream pressure to atmosphere when closed (may also be known as 3-way or 3-way exhausting valves).
- I. Pressure regulators with the maximum outlet pressure adjusted to no more than 60 psi (~413 kPa),
- J. Pneumatic cylinders, pneumatic linear actuators, and rotary actuators,
- K. Pneumatic storage tanks (with the exception of White Clippard tanks P/N: AVT-PP-41), and
- L. Compressors compliant with R85.

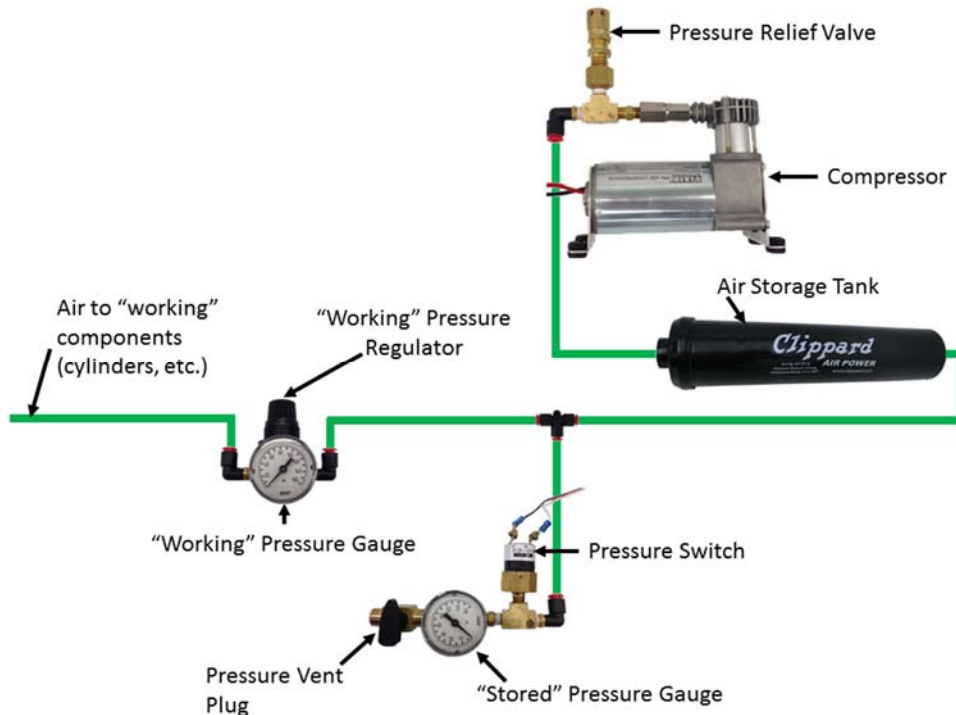
The following devices are not considered pneumatic devices and are not subject to pneumatic rules (though they must satisfy all other rules):

- A. a device that creates a vacuum
- B. closed-loop COTS pneumatic (gas) shocks
- C. air-filled (pneumatic) wheels
- D. pneumatic devices not used with pressurized air

R84. If pneumatic COMPONENTS are used, the following items are required as part of the pneumatic circuit and must be used in accordance with this section, as illustrated in Figure 8-14.

- A. One (1) FRC legal Compressor (per R85)
- B. Pressure relief valve (per R83-C) connected via legal rigid fittings (e.g. brass, nylon, etc.)
- C. Nason pressure switch, P/N SM-2B-115R/443
- D. At least one Pressure vent plug
- E. “Stored” pressure gauge (upstream from Primary Regulator, must show psi or kPa)
- F. “Working” pressure gauge (downstream from Primary Regulator, must show psi or kPa)
- G. “Working” pressure regulator

Figure 8-14: Pneumatic circuitry



- R85.** Throughout an event, compressed air on the ROBOT must be provided by its one compressor. Compressor specifications must not exceed nominal 1.10 cfm (~519 cm³/s) flow rate @ 12VDC.

A ROBOT'S compressor may be substituted by another compressor, but a ROBOT may only have one designated compressor at a time, and all compressed air on the ROBOT must be sourced from a single compressor.

For example, a team can't charge the circuit with an off-board compressor before the MATCH and then use a different on-board compressor to "top off" that circuit during the MATCH.

- R86.** The compressor (permitted per R85) may be located off-board the ROBOT, however the compressor must still be controlled and powered by the ROBOT when used.

The compressor may be mounted on the ROBOT, or it may be left off the ROBOT and used to pre-charge compressed air in storage tanks on the ROBOT provided the additional restrictions of R91 are met.

The intent of this rule is to permit teams to take advantage of the weight savings associated with keeping the compressor off-board. However, using the compressor off-board of the ROBOT does NOT permit non-compliance with any other applicable rules.

- R87.** "Stored" air pressure on the ROBOT must be no greater than 120 psi (~827 kPa). No stored air pressure intended for the ROBOT may be located off-board the ROBOT.

- R88.** "Working" air pressure on the ROBOT must be no greater than 60 psi (~413 kPa) and must be provided through a single primary adjustable, relieving, pressure regulator.

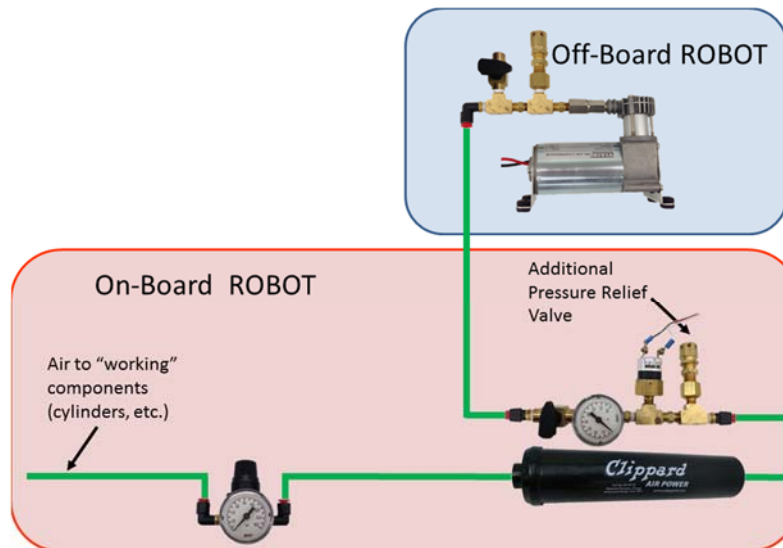
Norgren regulator P/N: R07-100-RNEA or Monnier P/N: 101-3002-1 recommended.

- R89.** Only the compressor, relief valve, pressure switch, pressure vent plug, pressure gauge, storage tanks, tubing, pressure transducers, and connecting fittings may be in the high-pressure pneumatic circuit upstream from the regulator.

It is recommended that all COMPONENTS in the high-pressure pneumatic circuit upstream from the regulator be rated for at least 115 psi (~793 kPa) working pressure.

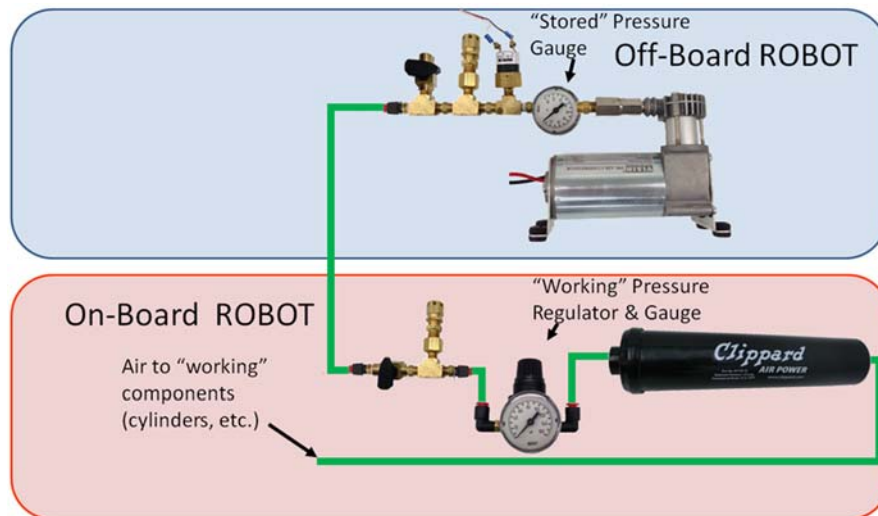
- R90.** Pressure gauges must be placed in easily visible locations upstream and downstream of the regulator to display the “stored” and “working” pressures.
- R91.** If the compressor is not included on the ROBOT (under the provisions of R87) the “stored” pressure gauge and pressure switch may be located on-board (Figure 8-15) or off-board (Figure 8-16) (but must be together), provided all other pneumatic rules are satisfied.

Figure 8-15: Off board compressor with stored pressure gauge and pressure switch on the ROBOT



- R92.** If the stored pressure gauge is kept off-board the ROBOT with the compressor, then only low-pressure (60 psi (~413 kPa) or less) “working” air can be stored on the ROBOT. The “working” pressure gauge must be installed on-board the ROBOT at all times (Figure 8-16).

Figure 8-16: Off board compressor with stored pressure gauge and pressure switch off the ROBOT



- R93.** The relief valve must be attached directly to the compressor or attached by legal hard fittings (e.g. brass, nylon, etc.) connected to the compressor output port. If using an off-board compressor, an additional relief valve must be included on the ROBOT.

Teams are required to check and/or adjust the relief valve to release air at 125 psi (~861 kPa). The valve may or may not have been calibrated prior to being supplied to Teams.

- R94.** The pressure switch requirements are:

- A.** It must be Nason P/N: SM-2B-115R/443
- B.** It must be connected to the high-pressure side of the pneumatic circuit (i.e. prior to the pressure regulator) to sense the “stored” pressure of the circuit.
- C.** The two wires from the pressure switch must be connected directly to the pressure switch input of the PCM controlling the compressor or, if controlled using the roboRIO and a Spike relay, to the roboRIO.
- D.** If connected to the roboRIO, the roboRIO must be programmed to sense the state of the switch and operate the relay module that powers the compressor to prevent over-pressuring the system.

- R95.** Any pressure vent plug must be:

- A.** connected to the pneumatic circuit such that, when manually operated, it will vent to the atmosphere to relieve all stored pressure in a reasonable amount of time, and
- B.** placed on the ROBOT so that it is visible and easily accessible.

If the compressor is not used on the ROBOT, then an additional pressure vent plug must be connected to the high-pressure portion of the pneumatic circuit off-board the ROBOT with the compressor (see R87).

- R96.** The outputs from multiple solenoid valves must not be plumbed together.

8.10 OPERATOR CONSOLE

- R97.** The Driver Station software provided on the [National Instruments website](#) is the only application permitted to specify and communicate the operating mode (i.e. Autonomous/Teleoperated) and operating state (Enable/Disable) to the ROBOT. The Driver Station software must be revision 18.0 or newer.

Teams are permitted to use a portable computing device of their choice (laptop computer, tablet, etc.) to host the DRIVER Station software while participating in competition MATCHES.

- R98.** The OPERATOR CONSOLE, the set of COMPONENTS and MECHANISMS used by the DRIVERS and/or HUMAN PLAYER to relay commands to the ROBOT, must include a graphic display to present the Driver Station diagnostic information. It must be positioned within the OPERATOR CONSOLE so that the screen display can be clearly seen during Inspection and in a MATCH.
- R99.** Devices hosting the Driver Station software must only interface with the Field Management System (FMS) via the Ethernet cable provided at the PLAYER STATION (e.g. not through a switch). Teams may connect the FMS Ethernet cable to their Driver Station device directly via an Ethernet pigtail, or with a single-port Ethernet converter (e.g. docking station, USB-Ethernet converter, Thunderbolt-Ethernet converter, etc.). The Ethernet port on the OPERATOR CONSOLE must be easily and quickly accessible.

Teams are strongly encouraged to use pigtails on the Ethernet port used to connect to the FMS. Such pigtails will reduce wear and tear on the device's port and, with proper strain relief employed, will protect the port from accidental damage.

- R100.** The OPERATOR CONSOLE must not
- A.** be longer than 60 in. (~152 cm)
 - B.** be deeper than 14 in. (~35 cm) (excluding any items that are held or worn by the DRIVERS during the MATCH)
 - C.** extend more than 6 ft. 6 in. (~198 cm) above the floor
 - D.** attach to the ARCADE (except as permitted by G19)

There is a 54 in. (~137 cm) long by 2 in. (nominal) wide strip of hook-and-loop tape ("loop" side) along the center of the PLAYER STATION support shelf that should be used to secure the OPERATOR CONSOLE to the shelf, per G19. See [Section 3.6.1 PLAYER STATION](#) for details.

Please note that while there is no hard weight limit, OPERATOR CONSOLES that weigh more than 30 lbs. (~13 kg.) will invite extra scrutiny as they are likely to present unsafe circumstances.

- R101.** Other than the system provided by the ARCADE, no other form of wireless communications shall be used to communicate to, from, or within the OPERATOR CONSOLE.

Examples of prohibited wireless systems include, but are not limited to, active wireless network cards and Bluetooth devices. For the case of the *FIRST* Robotics Competition, a motion sensing input device (e.g. Microsoft Kinect) is not considered wireless communication and is allowed.



R102. OPERATOR CONSOLES shall not be made using hazardous materials, be unsafe, cause an unsafe condition, or interfere with other DRIVE TEAMS or the operation of other ROBOTS.





9 Inspection & Eligibility Rules

This section describes the rules governing MATCH participation. A Team has participated in a MATCH if any member of their DRIVE TEAM is in the ALLIANCE STATION or PORTAL, with or without the ROBOT on the FIELD, at the start of the MATCH.

At each event, the Lead Robot Inspector (LRI) has final authority on the legality of any COMPONENT, MECHANISM, or ROBOT. Inspectors may re-Inspect ROBOTS to ensure compliance with the rules.

ROBOTS are permitted to participate in scheduled Practice MATCHES prior to passing Inspection. However, the *FIRST* Technical Advisor (FTA), LRI, or Head REFEREE may determine at any time that the ROBOT is unsafe, per safety rules, and may prohibit further participation in Practice MATCHES until the condition is corrected and/or the ROBOT passes Inspection.

Prior to the start of a MATCH, any ROBOT which is unable or ineligible to participate in that MATCH as determined by the FTA, LRI, or Head REFEREE is declared to be BYPASSED and is DISABLED. A Team whose ROBOT is BYPASSED remains eligible to receive Qualification Ranking Points or Playoff MATCH points provided that its ROBOT has passed Inspection, per I02.

- I01. The ROBOT must be built by the Team to play *FIRST*[®] POWER UPSM.** The ROBOT is an electromechanical assembly built by the *FIRST*[®] Robotics Competition Team to perform specific tasks when competing in *FIRST*[®] POWER UPSM. The ROBOT must include all of the basic systems required to be an active participant in the game – power, communications, control, BUMPERS, and movement. The ROBOT implementation must obviously follow a design approach intended to play *FIRST* POWER UP (e.g. a box of unassembled parts placed on the FIELD, or a ROBOT designed to play a different game, does not satisfy this definition).

I01 requires that the ROBOT a Team uses in competition was built by that Team, but isn't intended to prohibit assistance from other Teams (e.g. fabricating elements, supporting construction, writing software, developing game strategy, contributing COMPONENTS and/or MECHANISMS, etc.)

- I02. Get inspected before playing a Qualification/Playoff MATCH.** A Team is only permitted to participate in a Qualification or Playoff MATCH and receive Ranking or MATCH Points respectively if their ROBOT has passed an initial, complete Inspection.

Violation: If prior to the start of the MATCH, the Team is not eligible to participate in the MATCH. If after the start of the MATCH, the entire ALLIANCE receives a RED CARD for that MATCH.

Please take note of this rule. It is important that *FIRST* Robotics Competition Teams ensure their ALLIANCE partners have passed Inspection. Allowing a partner that has not passed Inspection to play puts the ALLIANCE at risk of RED CARDS. Teams should check with their ALLIANCE partners early, and help them pass Inspection before competing.

- I03. Bring it all to Inspection.** At the time of Inspection, the ROBOT must be presented with all MECHANISMS (including all COMPONENTS of each MECHANISM), configurations, and decorations that will be used on the ROBOT without re-inspection. It is acceptable, however, for a ROBOT to play MATCHES with a subset of the MECHANISMS that were present during Inspection. Only MECHANISMS that were present during the Inspection may be added, removed



or reconfigured between MATCHES. If MECHANISMS are changed between MATCHES, the reconfigured ROBOT must still meet all Inspection criteria.

- 104. Unless the change is listed below, any change to a ROBOT must get re-inspected.** If a ROBOT is modified after it has passed its most recent Inspection, that ROBOT must be re-Inspected before the ROBOT is eligible to participate in a MATCH. Exceptions are listed in A through F (unless they result in a significant change to the ROBOT'S size, weight, legality, or safety).
- A.** addition, relocation, or removal of fasteners (e.g. cable ties, tape, and rivets)
 - B.** addition, relocation, or removal of labeling or marking
 - C.** revision of ROBOT code
 - D.** replacement of a COTS COMPONENT with an identical COTS COMPONENT
 - E.** replacement of a MECHANISM with an identical MECHANISM (size, weight, material)
 - F.** additions, removals, or reconfiguration of ROBOT with a subset of MECHANISMS already inspected per I02.

When in doubt, the Team should ask to be re-Inspected.

Inspectors prioritize ROBOTS that have not yet completed initial inspection over ROBOT changes.

While every effort will be made to re-inspect Teams in a timely manner, Teams need to consider that they may need to play with the previously inspected configuration if re-inspection cannot be completed before a MATCH. Teams should work with Inspectors when making changes to minimize the chance of this occurring.

Example 1: Team A's ROBOT has passed Inspection, but burns out a motor controller during a MATCH. Team A replaces it with an identical motor controller. Team A does not have to get their ROBOT re-Inspected per exception I04-D.

Example 2: Team B would like to add weight to their ROBOT to lower their center of gravity. Team B adds a large amount of fasteners to their ROBOT as ballast. Team B must get their ROBOT re-Inspected because they have significantly changed their weight per I04.

Example 3: Team D has decided to move their motor controller to a different location on their ROBOT, and must use a different length wire to make the proper connections. Team D must get their ROBOT re-Inspected because rewiring is not an exception in I04.

Example 4: Team E decides to relocate their battery on their ROBOT to change their center of gravity. Team E must be re-Inspected as the relocation of COMPONENTS or MECHANISMS is not an exception I04.

Example 5: Team F realizes they can gain necessary functionality by building a new MECHANISM at an event and adding it to their ROBOT. Their ROBOT must be re-Inspected.

If an observation is made that another Team's ROBOT may be in violation of the ROBOT rules, please approach *FIRST* officials to review

the matter in question. This is an area where Gracious Professionalism® is very important.

- 105. Document your costs.** A Cost Accounting Worksheet (CAW), listing all items on the ROBOT except those listed in R11 and their relevant costs per [Section 8.4 Budget Constraints & Fabrication Schedule](#), must be presented at the time of Inspection.

Teams are encouraged to use the [CAW Template](#) posted on the *FIRST* website. Please note that while CAWs must be shown to Inspectors, Teams are not required to submit their CAWs to the Inspectors.

- 106. ROBOTS are off for Inspection, mostly.** For the safety of all those involved, Inspections must take place with the ROBOT powered off, pneumatics unpressurized, and springs or other stored energy devices in their lowest potential energy states (e.g. battery removed).

Power and air pressure should only be enabled on the ROBOT during those portions of the Inspection process where it is absolutely required to validate certain system functionality and compliance with specific rules (firmware check, etc.). Inspectors may allow the ROBOT to be powered up beyond the parameters above if both criteria below are met.

- A. The ROBOT design requires power or a charged stored energy device in order to confirm that the ROBOT meets volume requirements, and
- B. The Team has included safety interlocks that mitigate unexpected release of such stored energy.

The Team may be asked to demonstrate these interlocks during the inspection process.

- 107. No student, no Inspection.** At least one student Team member must accompany the ROBOT for any Inspection efforts.

Exceptions may be made for major conflicts, e.g. religious holidays, major testing, transportation issues, etc.



10 Tournaments

Each 2018 *FIRST* Robotics Competition event is played in a tournament format. Each tournament consists of three sets of MATCHES called Practice MATCHES (not necessarily played at all District Events), Qualification MATCHES, and Playoff MATCHES.

Practice MATCHES provide each Team with an opportunity to operate its ROBOT on the FIELD prior to the start of the Qualification MATCHES.

Qualification MATCHES allow each Team to earn a seeding position that may qualify them for participation in the Playoff MATCHES.

Playoff MATCHES determine the event Champions.

10.1 MATCH Schedules

A MATCH schedule is used to coordinate MATCHES at an Event. Figure 10-1 details information shown on each Schedule.

Figure 10-1: Sample MATCH Schedule

Qualification Match Schedule

Event Name

Matches Per Team		10	ALLIANCE Red or Blue			PLAYER STATION number 1, 2, or 3		
Time	Description	Match	Blue 1	Blue 2	Blue 3	Red 1	Red 2	Red 3
Thu 2:30	Qualification 1	1	1	2	3	4	5	6
Thu 2:37	Qualification 2	2	7	8	9	10		12
Thu 2:44	Qualification 3	3	13	14	15*	16	17	18

MATCH Start Time MATCH Type MATCH Number Asterisk (*) indicates SURROGATE MATCH

10.2 Practice MATCHES

Practice MATCHES are played on the first day of each event. The Practice MATCH schedule is available as soon as possible, but no later than the start of Practice MATCHES. It will also be published and available online at the [FIRST Robotics Event Results site](#), except during exceptional circumstances. Practice MATCHES are randomly assigned, and teams may not switch scheduled Practice MATCHES. Each Team is assigned an equal number of Practice MATCHES unless the number of Teams multiplied by number of Practice MATCHES is not divisible by six. In this case, the FIELD Management System (FMS) randomly selects some Teams to play an extra Practice MATCH.

Practice MATCHES are not guaranteed at District Events due to event schedule constraints.

10.2.1 Filler Line

A Filler Line is used to fill open slots at events that employ scheduled Practice MATCHES or all slots at events with an open Practice MATCH schedule. Teams from the Filler Line are used on a first come, first served basis to fill empty spots in Practice MATCHES left by other Teams that do not report to Queueing. The number of Teams in the Filler Line is dependent upon space at venues



- T01.** Teams wanting additional Practice MATCHES may not join the Filler Line unless all criteria listed below are met:
- A.** ROBOTS in the Filler Line must have passed Inspection (this requirement may be waived for events with open Practice MATCH schedules);
 - B.** DRIVE TEAMS must join the Filler Line with their ROBOT;
 - C.** Teams may not work on their ROBOT while in the Filler Line;
 - D.** Teams may not occupy more than one spot in the Filler Line; and
 - E.** If a Team is queued for their Practice MATCH, they may not also join the Filler Line.

10.3 Measurement

The ARCADE will be open for at least thirty (30) minutes prior to the start of Qualification MATCHES, during which time Teams may survey and/or measure the FIELD and bring ROBOTS on the FIELD to perform sensor calibration. The specific time that the FIELD is open will be communicated to Teams at the event. Teams may bring specific questions or comments to the FTA.

- T02.** During the period when the ARCADE is open for measurement, ROBOTS can be enabled, but cannot move, nor can they interact with (e.g. shoot, push, pickup, etc.) POWER CUBES, the SWITCHES, or SCALE.

Violation: Discussion with Team, if repeated or egregious YELLOW CARD.

10.4 Qualification MATCHES

10.4.1 Schedule

The Qualification MATCH schedule is made available as soon as possible, but no later than one (1) hour before Qualification MATCHES are scheduled to begin. Teams receive one (1) hard copy and it is available online at <https://frc-events.firstinspires.org>, except during exceptional circumstances. Each Qualification schedule consists of a series of rounds in which each Team plays one (1) MATCH per round.

10.4.2 MATCH Assignment

FMS assigns each team two (2) ALLIANCE partners for each Qualification MATCH using a predefined algorithm, and teams may not switch Qualification MATCH assignments. The algorithm employs the following criteria, listed in order of priority:

1. maximize time between each MATCH played for all Teams
2. minimize the number of times a Team plays opposite any Team
3. minimize the number of times a Team is allied with any Team
4. minimize the use of SURROGATES (Teams randomly assigned by the FMS to play an extra Qualification MATCH)
5. provide even distribution of MATCHES played on Blue and Red ALLIANCE
6. provide even distribution of MATCHES played in each PLAYER STATION number.

All Teams are assigned the same number of Qualification MATCHES, equal to the number of rounds, unless the number of Teams multiplied by number of MATCHES is not divisible by six. In this case, the FMS randomly selects some Teams to play an extra MATCH. For the purpose of seeding calculations, those Teams are designated as SURROGATES for the extra MATCH. If a Team plays a MATCH as a SURROGATE, it is indicated on the MATCH schedule, it is always their third Qualification MATCH, and

the outcome of the MATCH has no effect on the Team’s ranking. YELLOW and RED CARDS assigned to SURROGATES, however, do carry forward to subsequent MATCHES.

10.4.3 Qualification Ranking

Ranking Points (RP) are units credited to a Team based on their ALLIANCE’S performance in Qualification MATCHES. Ranking Points are awarded to each eligible Team at the completion of each Qualification MATCH per Table 4-1.

Exceptions to Ranking Point assignment are as follows:

- A. A SURROGATE receives zero (0) Ranking Points.
- B. A DISQUALIFIED Team, as determined by the Head REFEREE, receives zero (0) Ranking Points in a Qualification MATCH or causes their ALLIANCE to receive zero (0) MATCH points in a Playoff MATCH.
- C. A “no-show” Team is either DISQUALIFIED from or issued a RED CARD for that MATCH (see C06). A Team is declared a no-show if no member of the DRIVE TEAM is in the ALLIANCE STATION or PORTAL at the start of the MATCH.

The total number of Ranking Points earned by a Team throughout their Qualification MATCHES divided by the number of MATCHES they’ve been scheduled to play (minus any SURROGATE MATCH), then truncated to two (2) decimal places, is their Ranking Score (RS).

All Teams participating in Qualification MATCHES are ranked by Ranking Score. If the number of Teams in attendance is ‘n’, they are ranked ‘1’ through ‘n’, with ‘1’ being the highest ranked Team and ‘n’ being the lowest ranked Team.

Teams are ranked in order, using the sorting criteria defined in Table 10-1

Table 10-1: Qualification MATCH Ranking Criteria

Order Sort	Criteria
1 st	Ranking Score
2 nd	Cumulative PARKING and CLIMBING score
3 rd	Cumulative sum of AUTO points
4 th	Cumulative sum of OWNERSHIP points
5 th	Cumulative sum of VAULT points
6 th	Random sorting by the FMS

10.5 Playoff MATCHES

In Playoff MATCHES, Teams do not earn Ranking Points; they earn a Win, Loss or Tie. Within each series of the Playoff MATCH bracket, the first ALLIANCE to win two (2) MATCHES will advance.

In the case where the Quarterfinal or Semifinal MATCH scores for both ALLIANCES are equal, the Win is awarded to the ALLIANCE per criteria listed in Table 10-2. A DISQUALIFIED Team, as determined by the Head REFEREE, causes their ALLIANCE to receive zero (0) MATCH points in a Playoff MATCH.

In Finals MATCHES, the Champion ALLIANCE is the first ALLIANCE to win two (2) MATCHES. In the case where an ALLIANCE hasn’t won two (2) MATCHES after three (3) MATCHES, the Playoffs proceed with up to three (3) additional Finals MATCHES, called Overtime MATCHES, until an ALLIANCE has won two (2) Finals MATCHES. In the case where the Overtime MATCH scores for both ALLIANCES are equal, the win for that Overtime MATCH is awarded based on the criteria listed in Table 10-2.



Table 10-2: Quarterfinal, Semifinal, and Overtime Tiebreaker Criteria

Order Sort	Criteria
1 st	Fewer FOUL and TECH FOUL points awarded to the other ALLIANCE (i.e. the ALLIANCE that played the cleaner MATCH)
2 nd	Cumulative PARKING and CLIMBING score
3 rd	Cumulative sum of AUTO points
4 th	Cumulative sum of OWNERSHIP points
5 th	Cumulative sum of VAULT points
6 th	MATCH is replayed

10.5.1 ALLIANCE Selection Process

At the end of the Qualification MATCHES, the top eight (8) seeded Teams become the ALLIANCE Leads. The seeded ALLIANCES are designated, in order, ALLIANCE One, ALLIANCE Two, etc., down to ALLIANCE Eight. Using the ALLIANCE selection process described in this section, each ALLIANCE Lead chooses two (2) other Teams to join their ALLIANCE.

If a Team declines the ALLIANCE Lead position or doesn't send a student representative for ALLIANCE selection, they are ineligible to participate in the Playoff Tournament. If the declining/absent Team would have been an ALLIANCE Lead, all lower ranked ALLIANCE Leads are promoted one spot. The next highest-ranked Team moves up to become the ALLIANCE Eight Lead.

Each Team chooses a student Team representative who proceeds to the ARCADE at the designated time (typically before the lunch break on the final day of the event) to represent their Team. The designated student representative from each ALLIANCE in a Playoff MATCH is called the ALLIANCE CAPTAIN.

The ALLIANCE selection process consists of two (2) rounds during which each ALLIANCE CAPTAIN invites a Team seeded below them in the standings to join their ALLIANCE. The invited Team must not already have declined an invitation.

Round 1: In descending order (ALLIANCE One to ALLIANCE Eight), each ALLIANCE CAPTAIN invites a single Team. The invited Team's representative steps forward and either accepts or declines the invitation.


If the Team accepts, it becomes a member of that ALLIANCE. If an invitation from a top eight ALLIANCE to another ALLIANCE Lead is accepted, all lower ALLIANCE Leads are promoted one spot. The next highest-seeded, unselected Team moves up to become the ALLIANCE Eight Lead.

If the Team declines, that Team is not eligible to be picked again or to be a BACKUP TEAM (see [Section 10.5.2 BACKUP TEAMS](#)), and the ALLIANCE CAPTAIN extends another invitation to a different Team. If an invitation from a top eight ALLIANCE to another ALLIANCE Lead is declined, the declining Team may still invite Teams to join their ALLIANCE; however, it cannot accept invitations from other ALLIANCES.

The process continues until ALLIANCE Eight makes a successful invitation.

Round 2: The same method is used for each ALLIANCE CAPTAIN'S second choice except the selection order is reversed, with ALLIANCE Eight picking first and ALLIANCE One picking last. This process results in eight (8) ALLIANCES of three (3) Teams each.

Of the remaining eligible Teams, the highest seeded Teams must either accept or decline to be included in a pool of available Teams until there are up to eight (8) Teams that accept to be added into the pool. FIELD STAFF will coordinate the assembly of this BACKUP pool immediately after the top ranked



ALLIANCE has made their final pick. If a Team is not available to accept inclusion in the BACKUP pool, it will be assumed they have declined the invitation.

10.5.2 BACKUP TEAMS

In the Playoff MATCHES, it may be necessary for an ALLIANCE to replace one of its members due to a faulty ROBOT. ROBOT faults include but are not limited to:

1. mechanical damage,
2. electrical issues, or
3. software problems.

In this situation, the ALLIANCE CAPTAIN has the option to bring in only the highest seeded Team from the pool of available Teams to join its ALLIANCE. The Team whose ROBOT and DRIVE TEAM replaces another ROBOT and DRIVE TEAM on an ALLIANCE during the Playoff MATCHES is called the BACKUP TEAM.

The resulting ALLIANCE is then composed of four (4) Teams. The replaced Team remains a member of the ALLIANCE for awards, but cannot return to play, even if their ROBOT is repaired.

Each ALLIANCE is allotted one (1) BACKUP TEAM Coupon during the Playoff MATCHES. If a second ROBOT from the ALLIANCE becomes inoperable, then the ALLIANCE must play the following MATCHES with only two (2) (or even one (1)) ROBOTS.

Example: Three (3) Teams, A, B and C, form an ALLIANCE going into the Playoff MATCHES. The highest seeded Team not on one of the eight (8) ALLIANCES is Team D. During one of the Playoff MATCHES, Team C's ROBOT suffers damage to its mechanical arm. The ALLIANCE CAPTAIN decides to bring in Team D to replace Team C. Team C and their ROBOT are not eligible to play in any subsequent Playoff MATCHES. The new ALLIANCE of Teams A, B, and D are successful in advancing to the Finals and win the event. Teams A, B, C, and D are all recognized as members of the Winning ALLIANCE and receive awards

In the case where a BACKUP TEAM is part of the Winning or Finalist ALLIANCE, there will be a four (4)-Team Winning or Finalist ALLIANCE.

10.5.3 Playoff MATCH Bracket

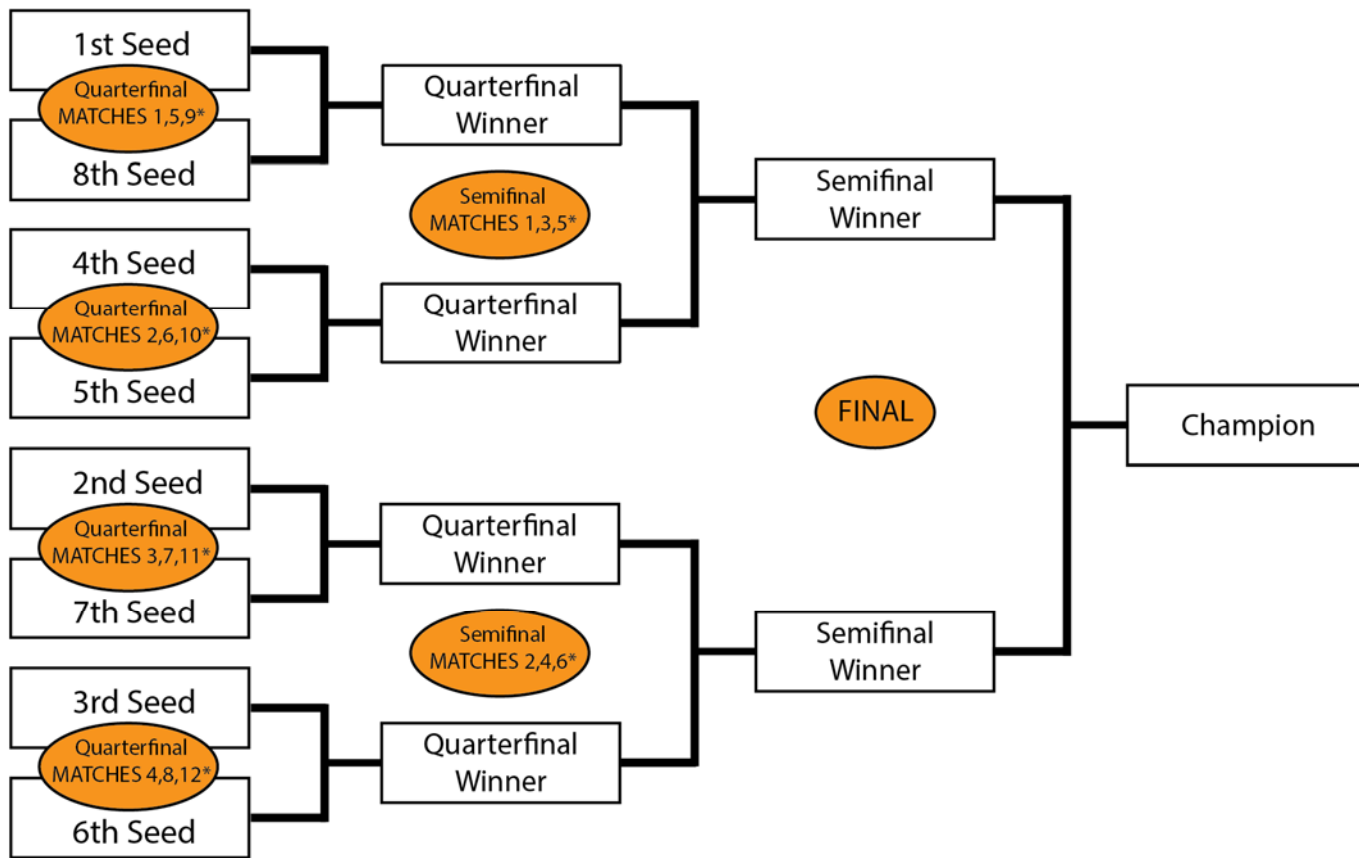
The Playoff MATCHES take place following the completion of the Qualification MATCHES and the ALLIANCE selection process. Playoff MATCHES are played in a bracket format as shown in Figure 10-2.

ALLIANCE Leads are assigned to PLAYER STATION 2, the first picks are assigned to their left in PLAYER STATION 1, and second picks are assigned to the ALLIANCE Lead's right in PLAYER STATION 3. If a BACKUP TEAM is in play, they will be assigned to the PLAYER STATION that was assigned to the DRIVE TEAM they're replacing. Teams cannot change assignments.

For Quarterfinal MATCHES, the higher seeded ALLIANCE is assigned to the Red ALLIANCE. Beyond the Quarterfinal MATCHES, the ALLIANCE on the top of each MATCH in Figure 10-2 are assigned to the Red ALLIANCE, regardless of whether they are the higher seeded ALLIANCE in that particular MATCH.



Figure 10-2: Playoff MATCH Bracket



*If necessary



In order to allow time between MATCHES for all ALLIANCES, the order of play is as follows:

Table 10-3: Playoff Order

Quarterfinal Round 1	Quarterfinal Round 2	Quarterfinal Round 3	Semifinals	Finals
Quarterfinal 1 (1 vs.8)	Quarterfinal 5 (1 vs.8)	Quarterfinal Tiebreaker 1 ¹	Semifinal 1	Final 1
Quarterfinal 2 (4 vs.5)	Quarterfinal 6 (4 vs.5)	Quarterfinal Tiebreaker 2 ¹	Semifinal 2	FIELD TIMEOUT
Quarterfinal 3 (2 vs.7)	Quarterfinal 7 (2 vs.7)	Quarterfinal Tiebreaker 3 ¹	Semifinal 3	Final 2
Quarterfinal 4 (3 vs.6)	Quarterfinal 8 (3 vs.6)	Quarterfinal Tiebreaker 4 ¹	Semifinal 4	FIELD TIMEOUT
	FIELD TIMEOUT ¹	FIELD TIMEOUT ¹	Semifinal Tiebreaker 1 ¹	Final Tiebreakers (Overtime) ¹
		Any Replays due to ties ¹	Semifinal Tiebreaker 2 ¹	
			FIELD TIMEOUT ¹	Any Replays due to ties ¹
			Any Replays due to ties ¹	

¹ - if required

10.6 REFEREE Interaction

The Head REFEREE has the ultimate authority in the ARCADE during the event, but may receive input from additional sources, e.g. Game Designers, *FIRST* personnel, FTA, and technical staff. The Head REFEREE rulings are final. No event personnel, including the Head REFEREE, will review video, photos, artistic renderings, etc. of any MATCH, from any source, under any circumstances.

If a DRIVE TEAM needs clarification on a ruling or score, per C08, one (1) pre-college student from that DRIVE TEAM should address the Head REFEREE after the ARCADE Reset Signal (e.g. LED lights turn green). A DRIVE TEAM member signals their desire to speak with the Head REFEREE by standing in the corresponding Red or Blue Question Box, which are located on the floor near each end of the scoring table. Depending on timing, the Head REFEREE may postpone any requested discussion until the end of the subsequent MATCH as necessary.

While FMS tracks quantities of FOULS and TECH FOULS, *FIRST* instructs REFEREES to not self-track details about FOULS and TECH FOULS; as a result, we don't expect REFEREES to recall details about what FOULS or TECH FOULS were made, when they occurred, and against whom.

Any reasonable question is fair game in the Question Box, and Head REFEREES will do good faith efforts to provide helpful feedback (e.g. how/why certain FOULS are being called, why a particular ROBOT may be susceptible to certain FOULS based on its design or game play, how specific rules are being called or interpreted), but please know that they will likely not be able to supply specific details

10.7 YELLOW and RED CARDS

In addition to rule violations explicitly listed throughout the **2018 Game and Season Manual**, YELLOW CARDS and RED CARDS are used in **FIRST® Robotics Competition** to address Team and ROBOT behavior that does not align with the mission of **FIRST®**.

As noted in [Section 4.4 Rule Violations](#) and C01, the Head REFEREE may assign a YELLOW CARD as a warning, or a RED CARD for DISQUALIFICATION in MATCH for egregious behavior inappropriate at a **FIRST Robotics Competition** event.

T03. Egregious or repeated violations of any rule or procedure is prohibited.

Violation: The Head REFEREE may assign a YELLOW CARD as a warning, or a RED CARD for DISQUALIFICATION in MATCH.

A YELLOW or RED CARD is indicated by the Head REFEREE standing in front of the Team's PLAYER STATION and holding a YELLOW and/or RED CARD in the air.

YELLOW CARDS are additive, meaning that a second YELLOW CARD is automatically converted to a RED CARD. A Team is issued a RED CARD for any subsequent incident in which they receive an additional YELLOW CARD, including earning a second YELLOW CARD during a single MATCH. A second YELLOW CARD is indicated by the Head REFEREE standing in front of the Team's PLAYER STATION and holding a YELLOW CARD and RED CARD in the air simultaneously after the completion of the MATCH. A Team that has received either a YELLOW CARD or a RED CARD carries a YELLOW CARD into subsequent MATCHES, except as noted below. A RED CARD results in DISQUALIFICATION.

Once a Team receives a YELLOW or RED CARD, its Team number will be presented with a yellow background on the audience screen at the beginning of all subsequent MATCHES, including any replays, as a reminder to the Team, the REFEREES, and the audience that they carry a YELLOW CARD.

Figure 10-3: Audience Screen Graphic Showing YELLOW CARD Indicators



All YELLOW CARDS are cleared at the conclusion of Qualification MATCHES, providing teams a clean slate at the beginning of Playoff MATCHES.

During the Playoff MATCHES, if a Team receives a YELLOW or RED CARD, it results in the entire ALLIANCE receiving the YELLOW or RED CARD for that MATCH. If two different Teams on the same ALLIANCE are issued YELLOW CARDS, the entire ALLIANCE is issued a RED CARD. A RED CARD results in zero (0) points for that MATCH, and the ALLIANCE loses the MATCH. If both ALLIANCES receive RED CARDS, the ALLIANCE which committed the action earning the RED CARD first chronologically loses the MATCH.



YELLOW and RED CARDS are applied based on the following:

Table 10-4: YELLOW and RED CARD application

Time YELLOW or RED CARD earned:	MATCH to which CARD is applied:
prior to the start of Qualification MATCHES	Team's first Qualification MATCH
during the Qualification MATCHES	Team's current (or just-completed) MATCH. In the case where the Team participated as a SURROGATE in the current (or just completed) MATCH, the card is applied to the Team's previous MATCH (i.e. the Team's second Qualification MATCH.)
between the end of Qualification MATCHES and the start of Playoff MATCHES	ALLIANCE'S first Playoff MATCH
during the Playoff MATCHES	ALLIANCE'S current (or just-completed) MATCH.

10.8 MATCH Replays

Over the course of the Tournament it may be necessary for a MATCH to be replayed. Typical causes for replays are MATCHES that end in a tie during the Playoffs or if there is an ARCADE FAULT. An ARCADE FAULT is an error in ARCADE operation that includes, but is not limited to:

- A. broken FIELD elements due to
 - i. normal, expected game play or
 - ii. ROBOT abuse of FIELD elements that affects the outcome of the MATCH for their opponents.

A broken FIELD element caused by ROBOT abuse that affects the outcome of the MATCH for their ALLIANCE is not an ARCADE FAULT.

- B. power failure to a portion of the FIELD (tripping the circuit breaker in the PLAYER STATION is not considered a power failure)
- C. improper activation by the FMS
- D. errors by FIELD staff (except those listed in Section 4.6)

If, in the judgment of the Head REFEREE, an ARCADE FAULT occurs that affects the outcome of the MATCH and any team on the affected ALLIANCE desires a replay, the MATCH will be replayed.

The outcome of the MATCH is affected if an error occurs that, in the judgement of the Head REFEREE changes which ALLIANCE would have won the MATCH and/or the assignment of Ranking Points.

All reasonable effort is made to create the same conditions when replaying a MATCH. This means, for example, that a Team which was BYPASSED during the MATCH which is to be replayed, is BYPASSED for the replay MATCH.

POWER CUBES not detected because of logo-side-up placement in the VAULT, per Section 3.6.3 VAULT, do not result in an ARCADE FAULT.

Note that an ARCADE FAULT that does not affect MATCH outcome in the judgement of the Head REFEREE does not lead to a MATCH replay. Examples include, but are not limited to:

- A. a piece of FIELD plastic falls into the FIELD, far away from any human or ROBOT activity, and in such a way that it does not affect MATCH outcome
- B. delay in the playing of an ARCADE sound
- C. mismatch between the timer on the Audience Screen and the FIELD Timer
- D. any adjustment or delay in assignment of a penalty (including those made after the MATCH)

10.9 TIMEOUTS and BACKUP TEAMS

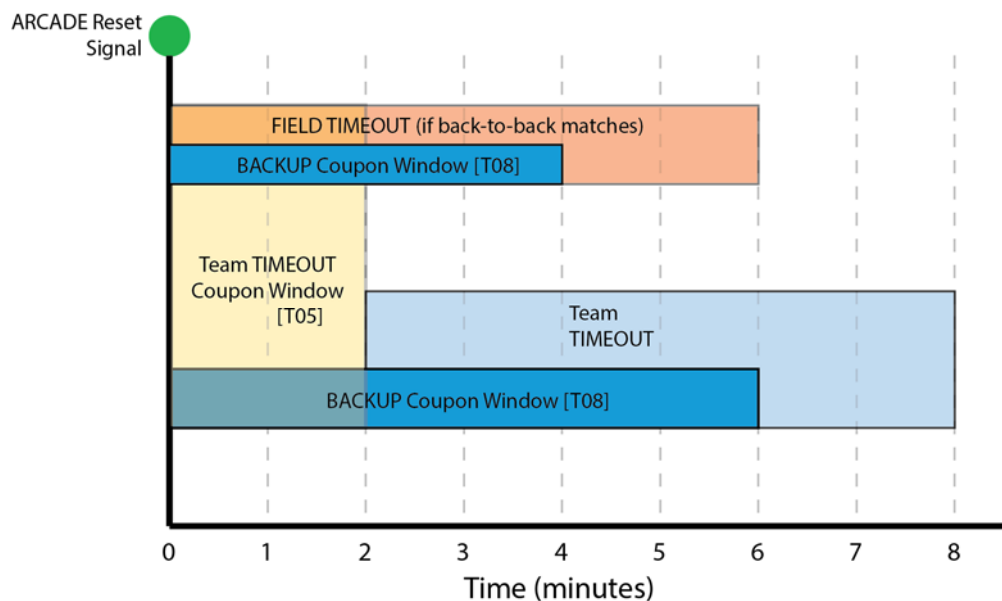
A TIMEOUT is a period of up to six (6) minutes between MATCHES which is used to pause Playoff MATCH progression.

During a TIMEOUT, the ARCADE Timer will display the time remaining in the TIMEOUT. Both ALLIANCES will enjoy the complete six (6) minute window. If an ALLIANCE completes their repairs before the ARCADE Timer expires, the ALLIANCE CAPTAIN is encouraged to inform the Head REFEREE that they are ready to play. If both ALLIANCES are ready to play before the TIMEOUT expires, the next MATCH will start.

There are no TIMEOUTS in the Practice or Qualification MATCHES.

If circumstances require an ALLIANCE to play in back-to-back MATCHES during the Playoff MATCHES, the Head REFEREE will issue a FIELD TIMEOUT to allow Teams to prepare for the next MATCH. FIELD TIMEOUTS are the same time duration as TIMEOUTS.

Figure 10-4: TIMEOUT Timeline



T04. An ALLIANCE may not call more than one (1) TIMEOUT during the Playoff MATCHES.

Teams are expected to have their ROBOTS staged on the FIELD by the end of the TIMEOUT. Teams that cause a significant delay to the start of a MATCH after a TIMEOUT are subject to G02.



- T05.** If an ALLIANCE wishes to call a TIMEOUT, the ALLIANCE CAPTAIN must submit their TIMEOUT coupon to the Head REFEREE within two (2) minutes of the ARCADE reset signal preceding their MATCH. If there is no preceding MATCH, the TIMEOUT coupon must be submitted no later than two (2) minutes before the scheduled MATCH time. The TIMEOUT will begin two (2) minutes after the ARCADE reset signal (i.e. at the end of the TEAM TIMEOUT Coupon Window depicted in Figure 10-4)
- T06.** There are no cascading TIMEOUTS. If an ALLIANCE calls a TIMEOUT during a FIELD TIMEOUT, the FIELD TIMEOUT will expire two (2) minutes after the ARCADE reset signal and the ALLIANCE'S TIMEOUT will begin.

If an ALLIANCE wishes to call a TIMEOUT during a FIELD TIMEOUT, it must still do so within two (2) minutes of the ARCADE reset signal preceding their MATCH, per T05.

- T07.** TIMEOUTS are not transferrable between ALLIANCES.

While TIMEOUTS are not transferrable between ALLIANCES, meaning an ALLIANCE cannot hand their designated TIMEOUT coupon to another ALLIANCE to use, an ALLIANCE may use their own coupon for any purpose they wish.

- T08.** If during a TIMEOUT an ALLIANCE CAPTAIN determines that they need to call up a BACKUP TEAM, they must submit their BACKUP TEAM coupon to the Head REFEREE while there are still at least two (2) minutes remaining on the ARCADE Timer. After that point, they will not be allowed to utilize the BACKUP TEAM.

Alternatively, an ALLIANCE CAPTAIN may choose to call up a BACKUP TEAM without using their TIMEOUT by informing the Head REFEREE directly within two (2) minutes of the Head REFEREE issuing the ARCADE reset signal preceding their MATCH. If there is no preceding MATCH, the BACKUP TEAM coupon must be submitted no later than two (2) minutes before the scheduled MATCH time.

In the case where the ALLIANCE CAPTAIN'S ROBOT is replaced by a BACKUP TEAM, the ALLIANCE CAPTAIN is allowed as a sixteenth ALLIANCE member.

The Head REFEREE will not accept the BACKUP TEAM coupon unless it lists the number of the Team whose ROBOT is being replaced, and is initialed by the ALLIANCE CAPTAIN. Once a BACKUP TEAM coupon is submitted and accepted by the Head REFEREE, the BACKUP TEAM coupon may not be withdrawn by the ALLIANCE.

- T09.** An ALLIANCE may request neither a TIMEOUT nor a BACKUP TEAM after a Playoff MATCH is stopped by the Head REFEREE (e.g. due to an ARCADE FAULT or a safety issue). The sole exception is if the replay is due to an ARCADE FAULT that rendered a ROBOT inoperable.

If a Playoff MATCH is replayed per T09, the Head REFEREE has the option of calling a FIELD TIMEOUT.

10.10 Pit Crews

During the Playoff MATCHES, extra Team members may be needed to maintain the ROBOT between MATCHES because of the distance between the FIELD and the pit area. Each Team is permitted to have three (3) additional pit crew members who can also help with needed ROBOT repairs/maintenance

- T10.** Pit Crew members may not be in the ALLIANCE STATION or PORTAL during a MATCH.

Violation: MATCH will not start until the situation is corrected. Those not displaying identification must leave the ARCADE.

10.11 *FIRST* Championship Additions and Exceptions

At the 2018 *FIRST* Championship events, Teams are split into six (6) Subdivisions. Each Subdivision plays a standard Tournament as described in [Section 10 Tournaments](#) to produce the Subdivision Champions. Those six (6) Subdivision Champions proceed to the Championship Playoffs, on the Einstein FIELDS, to determine the 2018 *FIRST*® Robotics Competition Championship Winners, per Section 10.11.3..

There is no provision for BACKUP TEAMS at the Championship.

10.11.1 Four ROBOT ALLIANCES

Before each Subdivision Playoff Tournament, ALLIANCES will be selected per the process as described in [Section 10.5.1 ALLIANCE Selection Process](#), however the process will continue with a 3rd round of selection as follows.

Round 3: The same method is used for each ALLIANCE CAPTAIN'S third choice except the selection order is reversed again, with ALLIANCE One picking first and ALLIANCE Eight picking last. This process results in eight (8) ALLIANCES of four (4) Teams each.

ALLIANCES may start with any three (3) of the four (4) ROBOTS on their ALLIANCE during Subdivision Playoff MATCHES and during the Championship Playoffs. The list of three (3) Teams participating in the MATCH and their selected PLAYER STATIONS is called the LINEUP. One representative from the Team not on the LINEUP is allowed as a sixteenth ALLIANCE member. This additional representative may only serve in an advisory role, and will be considered a COACH (e.g. can't be a HUMAN PLAYER).

T11. The ALLIANCE CAPTAIN must report the LINEUP to the Head REFEREE, or their designee, in writing prior to end of the preceding MATCH (e.g. the LINEUPS for Quarterfinal 2 must be submitted before the end of Quarterfinal 1). If there is no preceding MATCH, the LINEUP is due no later than two (2) minutes before the scheduled MATCH time.

Violation: The LINEUP is the same as the ALLIANCE'S previous MATCH. If any of these three (3) ROBOTS are unable to play, the ALLIANCE must play the MATCH with only two (2) (or even one (1)) ROBOTS

If an ALLIANCE fails to submit a LINEUP per the process defined in T11 and the MATCH is their first of the Subdivision Playoffs or the Championship Playoffs, the LINEUP will be the ALLIANCE Lead, first ALLIANCE selection, and second ALLIANCE selection. If any of these three (3) ROBOTS are unable to play, the ALLIANCE must play the MATCH with only two (2) (or even one (1)) ROBOTS.

The LINEUP will be kept confidential until the FIELD is set for the MATCH, at which point each ALLIANCE'S LINEUP will appear on the Team Signs.

T12. Once the LINEUP has been declared, it cannot be changed unless there is a TIMEOUT. If there is a TIMEOUT, the ALLIANCE CAPTAIN may submit a different LINEUP, but must do so while there are still more than two (2) minutes remaining in the TIMEOUT.

Example: Four (4) Teams, A, B, C and D, form an ALLIANCE going into the Playoff MATCHES on their Subdivision FIELD. During one of the Playoff MATCHES, Team C's ROBOT becomes inoperable. The ALLIANCE decides to bring in Team D to replace Team C. Team C repairs their ROBOT and may play in any subsequent Playoff MATCHES replacing Teams A, B, or D. All four (4) ALLIANCE members are also eligible to play MATCHES during the Championship Playoffs should the ALLIANCE win the Subdivision Tournament.



T13. If a MATCH must be replayed due to an ARCADE FAULT, the LINEUP for the replayed MATCH is the same as the original MATCH. The sole exception is if the ARCADE FAULT rendered a ROBOT inoperable, in which case the LINEUP can be changed.

10.11.2 FIRST Championship Pit Crews

FIRST will distribute buttons to the ALLIANCE CAPTAINS during the ALLIANCE CAPTAIN meeting, which takes place on the Subdivision FIELDS. These buttons will provide the necessary access to the ARCADE for pit crew members.

T14. Only Team members wearing proper buttons are allowed on the ARCADE floor during Subdivision and Championship Playoff MATCHES

Violation: MATCH will not start until the situation is corrected. Those not displaying identification must leave the ARCADE.

Teams should assume they may be chosen for an ALLIANCE and think about the logistics of button distribution and set a plan prior to the ALLIANCE selection process. It is each ALLIANCE CAPTAIN'S responsibility to get the Team's buttons to the pit crew members.

10.11.3 FIRST Championship Playoffs

The six (6) Subdivision Champions play a round-robin style tournament to determine the 2018 FIRST Robotics Competition Champions. In this format, each Subdivision Champion plays one MATCH against each of the other Subdivision Champions. The order of MATCHES is shown in Table 10-5.

Table 10-5: Championship MATCH order

Round	MATCH	Houston				Detroit			
		Mass		Energy		Mass		Energy	
		Red	Blue	Red	Blue	Red	Blue	Red	Blue
1	1	Carver	Turing			Archimedes	Tesla		
	2			Galileo	Roebing			Carson	Darwin
	3	Hopper	Newton			Curie	Daly		
2	4			Carver	Roebing			Archimedes	Darwin
	5	Turing	Newton			Tesla	Daly		
	6			Galileo	Hopper			Carson	Curie
3	7	Carver	Newton			Archimedes	Daly		
	8			Roebing	Hopper			Darwin	Curie
	9	Turing	Galileo			Tesla	Carson		
4	10			Hopper	Carver			Curie	Archimedes
	11	Newton	Galileo			Daly	Carson		
	12			Roebing	Turing			Darwin	Tesla
5	13	Galileo	Carver			Carson	Archimedes		
	14			Hopper	Turing			Curie	Tesla
	15	Newton	Roebing			Daly	Darwin		

In the Championship Playoffs, ALLIANCES do not earn Ranking Points; they earn Championship Points. Championship Points are units credited to an ALLIANCE based on their performance in each MATCH and are awarded at the completion of each Round Robin tournament MATCH.



- A. The winning ALLIANCE receives two (2) Championship Points
- B. The losing ALLIANCE receives zero (0) Championship Points
- C. In the event of a tied score, each ALLIANCE receives one (1) Championship Point

Exceptions to A-C are as follows:

- D. A DISQUALIFIED Team, as determined by the Head REFEREE, causes their ALLIANCE to receive zero (0) Championship points.

The total number of Championship Points earned by a Team throughout the round robin MATCHES divided by the number of round robin Matches in which they've been scheduled is their Championship Score (CS).

All Teams participating in round robin Matches are ranked by Championship Score. If the number of Teams in attendance is 'n', they are ranked '1' through 'n', with '1' being the highest ranked Team and 'n' being the lowest ranked Team.

Table 10-6: Einstein Tournament Ranking Criteria

Order Sort	Criteria
1 st	Championship Score
2 nd	Cumulative PARKING AND CLIMBING points
3 rd	Cumulative sum of AUTO points
4 th	Cumulative sum of OWNERSHIP points
5 th	Cumulative sum of VAULT points
6 th	<ul style="list-style-type: none"> • If tie affects which ALLIANCES advance to Playoffs, a tiebreaker MATCH is played between the affected ALLIANCES. • If tie is between ALLIANCES advancing to Playoffs, FMS randomly seeds tied alliances to determine ALLIANCE color.

The two ALLIANCES with the highest Championship Scores at the conclusion of the round robin tournament advance to the Einstein Finals. In the Einstein Finals, ALLIANCES do not earn points, they earn a Win, Loss or Tie. The first ALLIANCE to win two (2) MATCHES is declared the 2018 *FIRST* Robotics Competition Champions.

T15. During the Einstein Finals, if the MATCH score of each ALLIANCE is equal, the MATCH is replayed.

If an Einstein Finals MATCH is replayed per T15, the LINEUP can be changed

10.11.4 *FIRST* Championship TIMEOUTS

There are no TIMEOUTS for teams in the Einstein tournament.

10.12 Advancement Between Tournaments

Teams advance through the season depending on the events at which they compete: Regional or District. This section details how teams advance from Regional events to the *FIRST* Championship, or from District qualifying events, to their District Championship, to the *FIRST* Championship.

T16. A team is considered to have already earned a *FIRST* Championship invitation prior to the District, Regional, or District Championship if they are:

- A. pre-qualified or

A *FIRST*® Robotics Competition Team listed in the [Championship Eligibility Criteria document](#) is pre-qualified for the *FIRST* Championship if the Team meets one of the following criteria:

A. member of the *FIRST*® Hall of Fame

B. an original and sustaining team since 1992

C. a 2017 *FIRST* Championship winner

D. a 2017 *FIRST* Championship Engineering Inspiration Award winner

E. a 2017 *FIRST* Championship Chairman's Award Finalist

B. met the criteria outlined in T17 at a prior event.

10.12.1 Regional Events

T17. A Team competing at a Regional Event qualifies for the *FIRST* Championship by meeting one of the following criteria:

A. Winning a qualifying award:

i. Regional Chairman's Award

ii. Engineering Inspiration Award

iii. Rookie All-Star Award

B. A member of the Winning ALLIANCE

C. Earning a Wild Card

10.12.2 Wild Cards

Wild cards are used to qualify additional teams for the *FIRST* Championship from Regional events.

T18. All Regional events have a minimum of one (1) Wild Card slot. Additional Wild Cards are generated as follows:

A. Any team competing at a Regional event that has already qualified for the *FIRST* Championship prior to the Regional, per T16, and earns an additional spot, per T17, generates one (1) Wild Card.

B. Any team earning two (2) qualifying spots at a single Regional per T17 (e.g. by being on the Winning Alliance and earning the Chairman's Award) generates one (1) Wild Card.

C. A team who has already earned a spot at *FIRST* Championship prior to their current Regional, per T16, and earns two qualifying spots, per T17, will generate two Wild Card slots.

Wild Card slots are distributed to the Finalist ALLIANCE, in the order of team selection per [Section 10.5.1 ALLIANCE Selection Process](#), until either all Wild Card slots generated at that event are distributed or the Finalist ALLIANCE is out of teams, whichever comes first.

T19. If a member of the Finalist ALLIANCE has already qualified for the *FIRST* Championship, per T16, they are skipped and the next member of the ALLIANCE is awarded the available Wild Card.

T20. Unused Wild Card slots will not be backfilled or replaced.

A Team may decline a Wild Card, but this does not pass the Wild Card slot down to the next available Team. The Wild Card goes unused.

T21. Teams selected from the *FIRST* Championship Waitlist to participate at the *FIRST* Championship do not generate Wild Cards.

10.12.3 District Events

District teams are ranked throughout the season based on the points they earn at their first two home District events they attend, as well as at their District Championship. Points are awarded to teams as follows:

Table 10-7: District point assignment

Category	Points
Qualification Round Performance	$QualificationPoints(R, N, \alpha) = \left\lceil InvERF\left(\frac{N - 2R + 2}{\alpha N}\right) \left(\frac{10}{InvERF\left(\frac{1}{\alpha}\right)}\right) + 12 \right\rceil$ <p>(For a typically sized District event, this will result in a minimum of four (4) points being awards for Qualification round performance. For events of all sizes, a maximum of twenty-two (22) points will be awarded.)</p>
ALLIANCE CAPTAINS	Equal to 17 minus the ALLIANCE CAPTAIN number (e.g. 14 points for ALLIANCE #3 Captain)
Draft Order Acceptance	Equal to 17 minus the Draft Order Acceptance Number (e.g. 12 points for the Team that is 5 th to accept an invitation)
Playoff Advancement	Points awarded based on team participation in individual playoff rounds, and whether or not the ALLIANCE advances. See details below.
Judged Team Awards	<ul style="list-style-type: none"> • 10 points for Chairman’s Award • 8 points each for Engineering Inspiration and Rookie All Star Awards • 5 points each for all other judged Team awards
Team Age	<ul style="list-style-type: none"> • 10 points for Rookie Teams • 5 points for second-year Teams

Points earned at District Championships are multiplied by three (3) and then added to points earned at District events, to determine the final season point total for the Team



If there is a tie in the season point total between teams, those items are broken using the following sorting criteria:

Table 10-8: District Team sort criteria

Order Sort	Criteria
1 st	Total Playoff Round Performance Points
2 nd	Best Playoff Round Finish at a single event
3 rd	Total ALLIANCE Selection Results Points
4 th	Highest Qualification Round Seed or Draft Order Acceptance (i.e. Highest ALLIANCE Selection points at a single event)
5 th	Total Qualification Round Performance Points
6 th	Highest Individual MATCH Score, regardless of whether that score occurred in a Qualification or Playoff MATCH
7 th	Second Highest Individual MATCH Score, regardless of whether that score occurred in a Qualification or Playoff MATCH
8 th	Third Highest Individual MATCH Score, regardless of whether that score occurred in a Qualification or Playoff MATCH
9 th	Random Selection

10.12.3.1 Qualification Round Performance

The calculation of Qualification performance points is done using the equation (an inverse error function) in the table above. The equation utilizes the following variables:

- R – the qualification rank of the team at the event at the conclusion of Qualification MATCHES (as reported by FMS)
- N – the number of FIRST Robotics Competition teams participating in the Qualification rounds at the event
- Alpha (α) – a static value (1.07) used to standardize the distribution of points at events

This formula generates an approximately normal distribution of Qualification Round Performance points at an event, based on rank, with most teams getting a moderate number of points, and fewer teams getting the highest or lowest numbers of points available.

Table 10-9 displays sample Qualification Round Performance points for variously ranked teams at a forty (40) team event. The system will automatically generate the appropriate points for each team based on their rank and the number of teams at the event.


Table 10-9 Sample Qualification Round Point assignments

Rank	1	2	3	4	...	19	20	21	...	37	38	39	40
Points	22	21	20	19	...	13	13	12	...	6	6	5	4

10.12.3.2 ALLIANCE Selection Results

This attribute measures both individual Team qualification round seeding performance and recognition by peers.

ALLIANCE CAPTAINS are recognized based on their qualification round seeding rank. This rank is a result of the rules of the game, which typically incorporate several team performance attributes, and are designed to eliminate ties in rank. Non-ALLIANCE CAPTAINS are rewarded based on peer recognition. To be invited to join an ALLIANCE, a Team's peers have decided that the Team has attributes that are desirable. Giving points for ALLIANCE selection also supports come-from-behind Teams. A Team taking several MATCHES to optimize their performance may be recognized as a late bloomer by a top seeded Team, even if that performance isn't reflected in the rankings because of poor performance in early MATCHES. These points also have the potential to recognize Teams employing a minority strategy with



their ROBOT. Teams with unique or divergent ROBOT capabilities that complement the strengths of other ALLIANCE members may be selected to fill a strategic niche.

Note also that ALLIANCE CAPTAINS are given the same number of points as the Team drafted in the same sequence. For example, the third ALLIANCE CAPTAIN gets the same number of points as the third draft. Numerical analysis supports the idea that ALLIANCE CAPTAINS are about as strong in ROBOT performance as equivalently drafted Teams. As an additional minor benefit, awarding the same points for ALLIANCE CAPTAINS and equivalent drafts lubricates the acceptance of draft offers between ALLIANCE CAPTAINS, which gives Teams out of the top eight the chance to experience being ALLIANCE CAPTAINS themselves.

10.12.3.3 Playoff Round Performance

This attribute measures Team performance as part of an ALLIANCE.

All Teams on the ALLIANCE winning a particular playoff series, who participate in MATCHES with their ROBOTS, receive five (5) points per MATCH won. In most cases, Teams receive ten (10) points at each of the Quarterfinal, Semifinal, and Final levels, unless a BACKUP ROBOT is called in to play.

10.12.3.4 Awards

This attribute measures Team performance with respect to Team awards judged at the event.

The points earned for Team awards in this system are not intended to capture the full value of the award to the Team winning the award, or to represent the full value of the award to *FIRST*. In many ways, the Team's experience in being selected for awards, especially the Chairman's Award, the Engineering Inspiration Award, and the Rookie All Star Award, is beyond measure, and could not be fully captured in its entirety by any points-based system. Points are being assigned to awards in this system only to help Teams recognize that *FIRST*[®] continues to be "*More than Robots*[®]," with the emphasis on our cultural awards, and to assist in elevating award-winning Teams above non-award winning Teams in the ranking system.

Teams only get points for Team awards judged at the event. If an award is not judged, e.g. Rookie Highest Seed, is not for a Team, e.g. the Dean's List Award, or is not judged at the event, e.g. Safety Animation Award, sponsored by UL, no points are earned.

10.12.3.5 Team Age

This attribute recognizes the difficulty in being a Rookie or second-year Team.

Points are awarded to Rookie and second year Teams in recognition of the unique challenges Teams face in those early years, and to increase the chance that they will make it to the District Championship to compete with their ROBOTS. Like our dedicated Rookie awards, these additional points are intended to recognize and motivate newer participants in *FIRST*[®] Robotics Competition. These points are awarded once at the beginning of the season. Rookie year is calculated based on the year in which *FIRST* recognizes the Team as a Rookie.

10.12.3.6 Regional Participation

District Teams do not earn points for their actions at any Regionals they may attend, nor are eligible for *FIRST* Championship qualifying judged awards at those events. However, if a District Team does earn a slot at the *FIRST* Championship while attending a Regional event, that slot does count as part of the total Championship allocation the District is receiving for the season.

10.12.3.7 District Championship Eligibility

T22. A Team competing in a District qualifies for their District Championship by meeting one of the following criteria:



- A. District Chairman’s Award winner
- B. District Ranking; based on total points earned at their first two home District events as detailed in [Section 10.12.3 District Events](#).

Teams do not earn points at third or subsequent District events, nor at any inter-district or Regional events at which they compete during the 2018 season.

If a team declines an invitation to the District Championship, the next highest uninvited team on the list is invited, and so on, until the event capacity is filled.

- C. District Engineering Inspiration winner (qualifies to compete for the award only)
- D. District Rookie All Star winner (qualifies to compete for the award only)

The capacity of each District Championship is shown in Table 10-10. Each District determines the number of teams which qualify for their District Championship. These limits are based on factors including but not limited to the total number of teams in the District, available venue capacity, etc.

Table 10-10: 2018 District Championship Capacities

District Championship	2018 Team Capacity
<i>FIRST</i> Chesapeake District Championship	60
<i>FIRST</i> Israel District Championship	45
<i>FIRST</i> Mid-Atlantic District Championship	60
<i>FIRST</i> North Carolina State Championship	32
<i>FIRST</i> Ontario Provincial Championship	80
Indiana State Championship	32
Michigan State Championship	160
New England District Championship	54
Pacific Northwest District Championship	64
Peachtree District State Championship	45

10.12.3.8 *FIRST* Championship Eligibility for District Teams

Districts receive the percentage of 'available slots' at their assigned *FIRST* Championship location, rounded up to the nearest whole slot, equal to the percentage of teams they have in their District compared to the total of all *FIRST* Robotics Competition teams in the current season who would normally be assigned to their *FIRST* Championship location. 'Available slots' are calculated by taking the total number of slots at each *FIRST* Championship location, subtracting the number of pre-qualified teams assigned to that location, and also subtracting a 10% allowance for waitlisted teams, as Districts are still allowed to send waitlisted teams to the *FIRST* Championship. Further, this overall calculation uses a 'snapshot' of teams that have registered and paid as of a specific day a week or so after season payment due.

These slots are guaranteed to the Districts and populated with the following teams:

- qualifying award winners from the District Championship (Chairman’s Award, Engineering Award, and Rookie All Star winners),
- teams on the Winning Alliance from the District Championship (including any Back-Up teams participating),
- qualifying award winners among district teams who traveled to Regionals,

- teams on the final District ranking list, as deep in the ranking list as the District needs to go to fill their allocation.

If a District team earns a slot to the *FIRST* Championship within the season, but is not able to attend, the top ranked team who has not yet been offered a slot is given the opportunity, and so on, until all slots are filled. Slots for pre-qualified teams will not be backfilled.

Table 10-11 outlines the District Championship allocations for 2018. Districts determine the number of Dean's List, Chairman's, Rookie All Star, and Engineering Inspiration Awards to present at their Championship, within a range established by *FIRST*. The team counts are based on the team representation of the respective District at the respective Championship. For the awards, ranges are developed by using ratios agreed upon by *FIRST* and District Leadership. These ranges allow each District to represent their own community as they see fit. For the Chairman's Award, the ratios range from one (1) Chairman's Award Team for every eighteen (18) Championship District Teams to one (1) Chairman's Award Team for every nine (9) Championship District Teams. For the Dean's List Award, the ratios range from one (1) Dean's List Finalist for every nine (9) Championship District Teams to one (1) Dean's List Finalist for every six (6) Championship District Teams.

Table 10-11: District slot allocations for *FIRST* Championship

		Chairman's Award		Dean's List Award		Engineering Inspiration Award		Rookie All Star Award						
<i>FIRST</i> Championship Slots	<i>FIRST</i> Championship Normalized Slots	Max Ratio	Min Ratio	District Selection	Max Ratio	Min Ratio	District Selection	Min	Max	District Selection	Min	Max	District Selection	
<i>FIRST</i> Championship Detroit														
<i>FIRST</i> Chesapeake	21	1	3	2	2	4	4	1	2	2	1	2	1	
<i>FIRST</i> in Michigan	89	5	10	5	10	15	15	1	2	1	1	2	2	
<i>FIRST</i> Mid-Atlantic	22	1	2	2	2	4	4	1	2	2	1	2	1	
Indiana <i>FIRST</i>	9	1	1	1	2	2	2	1	2	1	1	2	1	
NE <i>FIRST</i>	37	2	4	4	4	6	5	1	2	2	1	2	2	
Ontario	29	2	3	3	3	5	5	1	2	1	1	2	1	
<i>FIRST</i> Championship Houston														
<i>FIRST</i> Israel	15	13	1	1	1	2	2	2	1	2	2	1	2	1
<i>FIRST</i> North Carolina	14	12	1	1	1	2	2	2	1	2	2	1	2	1
Pacific Northwest	32	28	2	3	3	3	5	5	1	2	2	1	2	2
Peachtree	16	14	1	2	2	2	2	2	1	2	2	1	2	2

All Districts, regardless of Championship Slot allocation, may award one (1) or two (2) Engineering Inspiration and Rookie All-Star Awards.



Chairman's Award and Dean's List Award maximums and minimums are determined by ratios applied to a given District's Championship Slot allocations. However, Districts assigned to Houston have relatively larger Championship slot allocations for a given team count compared to Districts assigned to Detroit, and we did not want these larger allocations to skew award allocations. So, for the purposes of award allocations only, Championship slots for Houston Districts were 'normalized', as shown in the table, reducing the slots allocated to what they would have been if both Championship geographies had the same total number of *FIRST* Robotics Competition teams. This 'normalized' slot allocation was then used to determine award minimums and maximums. As noted, these normalized slot values are used only for award allocations. The Houston-assigned Districts still retain the full Championship Slots Allocated (the larger number) shown in the table.

11 Glossary

Term	Definition
ACTIVE DEVICE	any device capable of dynamically controlling and/or converting a source of electrical energy by the application of external electrical stimulus
ALLIANCE	cooperatives of up to four (4) <i>FIRST</i> [®] Robotics Competition Teams
ALLIANCE CAPTAIN	The designated student representative from each ALLIANCE in a Playoff MATCH
ALLIANCE STATION	a 22 ft. (~671 cm) wide by 10 ft. (~305 cm) deep by 10 ft. (~305 cm) tall volume formed by, and including three (3) PLAYER STATIONS, an EXCHANGE wall, and 2 in. ALLIANCE colored gaffers tape
ALLIANCE WALL	the structure that separates ROBOTS from DRIVE TEAMS (except the TECHNICIAN) and consists of three (3) PLAYER STATIONS, and an EXCHANGE wall
ARCADE	all elements of the game infrastructure that are required to play <i>FIRST</i> [®] POWER UP SM : the FIELD, SWITCHES, the SCALE, VAULTS, carpet, the POWER CUBES, and all equipment needed for FIELD control, ROBOT control, and scorekeeping
ARCADE FAULT	an error in ARCADE operation that includes, but is not limited to those listed in Section 10.8 MATCH Replays .
AUTO	the first fifteen (0:15) seconds of a MATCH in which ROBOTS operate without any DRIVE TEAM control or input
AUTO LINE	a line of 2 in. (~5 cm), black gaffers tape that is the width of the FIELD and is 10 ft. (~305 cm) from each ALLIANCE WALL to the leading edge of the tape.
AUTO-RUN	The action of a ROBOT that breaks the vertical plane of the AUTO LINE with its BUMPER at any point in the AUTO stage
AUTO QUEST	An action by which an ALLIANCE completes three (3) AUTO-RUNS and has OWNERSHIP of their SWITCH at T=0 of the AUTO stage
BACKUP TEAM	The Team whose ROBOT and DRIVE TEAM replaces another ROBOT and DRIVE TEAM on an ALLIANCE during the Playoff MATCHES
BOOST	a POWER UP which Doubles the points being earned by the ALLIANCE for OWNERSHIP of their SWITCH, SCALE, or both
BRICKS	graphics depicting golden squares surrounded by a black outline that extends 12 in. (~30cm) above the horizontal surface of the PLATFORM
BUMPER	a required assembly which attaches to the ROBOT frame. BUMPERS are important because they protect ROBOTS from damaging/being damaged by other ROBOTS and FIELD elements
BUMPER ZONE	the volume contained between the floor and a virtual horizontal plane 7½ in. (~19 cm) above the floor in reference to the ROBOT standing normally on a flat floor
BYPASSED	any ROBOT which is unable or ineligible to participate in that MATCH as determined by the FTA, LRI, or Head REFEREE resulting in a ROBOT which is disabled
CAW	Cost Accounting Worksheet
CLIMBING	A ROBOT fully supported by the SCALE (either directly or transitively) with BUMPERS fully above the BRICKS at T=0, not in direct contact with their PLATFORM, and not at all in the opponent's PLATFORM ZONE
COACH	a precollege student or adult mentor member of the DRIVE TEAM a guide or advisor
COMPONENT	any part in its most basic configuration, which cannot be disassembled without damaging or destroying the part or altering its fundamental function



COTS	a standard (i.e. not custom order) part commonly available from a VENDOR for all teams for purchase. To be a COTS item, the COMPONENT or MECHANISM must be in an unaltered, unmodified state (with the exception of installation or modification of any software)
CUSTOM CIRCUIT	any electrical COMPONENT of the ROBOT other than motors, pneumatic solenoids, roboRIO, PDP, PCM, VRM, RSL, 120A breaker, motor controllers, relay modules (per R35-B), wireless bridge, or batteries
DISABLED	a state in which a ROBOT is commanded to deactivate all outputs, rendering the ROBOT inoperable for the remainder of the MATCH
DISQUALIFIED	the state of a Team in which they receive zero (0) Match points in a qualification MATCH or causes their ALLIANCE to receive zero (0) Match points in a Playoff MATCH
DRIVER	a precollege student member of the DRIVE TEAM an operator and controller of the ROBOT
DRIVE TEAM	a set of up to five (5) people from the same FIRST Robotics Competition Team responsible for Team performance for a specific a MATCH
ENDGAME	The final thirty (30) seconds of the TELEOP stage
EXCHANGE	a polycarbonate wall 6 ft. 5 ¾ in. (~197 cm) tall by 4 ft. (~122 cm) wide located between PLAYER STATION 1 and PLAYER STATION 2 and used by ROBOTS to deliver POWER CUBES to HUMAN PLAYERS
EXCHANGE ZONE	A rectangular area 4 ft. (~122 cm) wide by 3 ft. (~91 cm) deep and infinitely tall volume bounded by the EXCHANGE wall and 2 in. (~5 cm) ALLIANCE colored gaffers tape. The EXCHANGE ZONE includes the tape, but excludes the wall
FABRICATED ITEM	any COMPONENT or MECHANISM that has been altered, built, cast, constructed, concocted, created, cut, heat treated, machined, manufactured, modified, painted, produced, surface coated, or conjured partially or completely into the final form in which it will be used on the ROBOT
FACE THE BOSS	An action where All three (3) ALLIANCE ROBOTS have CLIMBED or two (2) ROBOTS have CLIMBED and the ALLIANCE has played the LEVITATE POWER UP
FENCE	A structure surrounding a SWITCH made of aluminum shielded by polycarbonate. The FENCE is 12 ft. 9 ½ in. (~390 cm) wide by 4 ft. 8 in. (~142 cm) deep by 1 ft. 6 ¾ in. (~48 cm) tall.
FIELD	a 27 ft. (~823 cm) by 54 ft. (~1646 cm) carpeted area, bound by and including the inward-facing surfaces of the GUARDRAILS, PORTALS, EXCHANGE walls and ALLIANCE WALLS
FIELD STAFF	REFEREES, FTAs, or other staff working around the FIELD
FMS	the electronics core responsible for controlling the FIRST Robotics Competition playing field. The FMS encompasses all field electronics, including the computers, REFEREE touchscreens, wireless access point, sensors, stack lights, E-Stops, etc.
FORCE	A POWER UP which earns OWNERSHIP points from an ALLIANCE'S SWITCH, SCALE, or both regardless of PLATE position
FOUL	a penalty assessed by a REFEREE upon a rule violation resulting in 5 points credited towards the opponent's total score
FRAME PERIMETER	the polygon contained within the BUMPER ZONE, that is comprised of fixed, non-articulated structural elements of the ROBOT
FTA	a FIRST Technical Advisor
GUARDRAIL	a system that consists of transparent polycarbonate supported on the top and bottom by aluminum extrusion. The GUARDRAIL prevents ROBOTS from inadvertently exiting the FIELD during a MATCH
HUMAN PLAYER	a pre-college student DRIVE TEAM member responsible for managing a POWER CUBE manager



KOP	Kit of Parts, the collection of items listed on any Kickoff Kit Checklists, distributed via <i>FIRST</i> [®] Choice, or paid for completely (except shipping) with a Product Donation Voucher (PDV)
LEVITATE	A POWER UP which earns an ALLIANCE an additional CLIMBING ROBOT
LINEUP	The list of three (3) Teams participating in the MATCH and their selected PLAYER STATIONS
LRI	Lead ROBOT Inspector
MATCH	a two (2) minute and thirty (30) second period of time in which ALLIANCES play <i>FIRST POWER UP</i>
MECHANISM	a COTS or custom assembly of COMPONENTS that provide specific functionality on the ROBOT. A MECHANISM can be disassembled (and then reassembled) into individual COMPONENTS without damage to the parts
MXP	MyRIO eXpansion Port, the expansion port on the roboRIO
NULL TERRITORY	one of two, 7 ft. 11 ¼ in. (~242 cm) wide by 6 ft. (~183 cm) deep and infinitely tall volumes formed by 2 in. (~5 cm), white gaffers tape and the GUARDRAILS. The NULL TERRITORY includes the gaffers tape, but excludes the GUARDRAILS. The ALLIANCE'S NULL TERRITORY for a MATCH corresponds to the SCALE PLATE color in that NULL TERRITORY and does not change when the FORCE POWER UP is played
OPERATOR CONSOLE	the set of COMPONENTS and MECHANISMS used by the DRIVERS and/or HUMAN PLAYER to relay commands to the ROBOT
OUTRIGGERS	supports for the TOWER constructed from aluminum shielded by polycarbonate a state of the ALLIANCE'S SWITCH or SCALE where it is tilted in favor of an ALLIANCE colored PLATE, such that the outside edge of the ALLIANCE colored PLATE is at or less than a specified height above the carpet
OWNERSHIP	
PARKING	A ROBOT fully supported by the SCALE (either directly or transitively), not at all in the opponent's PLATFORM ZONE, and has not CLIMBED
PASSIVE CONDUCTORS	any device or circuit whose capability is limited to the conduction and/or static regulation of the electrical energy applied to it (e.g. wire, splices, connectors, printed wiring board, etc.)
PCM	Pneumatic Control Module
PDP	Power Distribution Panel
PLAYER STATION	one (1) of three (3) assigned positions in an ALLIANCE WALL from where a DRIVE TEAM operates their ROBOT
PLATE	One (1) of the two (2) assemblies at the extreme ends of the SWITCHES and SCALE which are 3 ft. (~91 cm) wide and 4 ft. (~122 cm) deep
PLATFORM	one of two (2) 8 ft. 8 in. (~264 cm) wide by 3 ft. 5 ¼ in. (~105 cm) deep and 3 ½ in. (~9 cm) tall surfaces located at the base of the SCALE and covered with ALLIANCE colored HDPE
PLATFORM ZONE	a 11 ft. 1 ½ in. (~339 cm) wide by 9 ft. 11 ¾ in. (~304 cm) deep and infinitely tall volume bounded by 2 in. (~5 cm) ALLIANCE colored gaffers tape, the faces of the OUTRIGGERS, TOWER, and the SWITCH. The PLATFORM ZONE includes the gaffers tape, but excludes the SWITCH and the faces of the OUTRIGGERS AND TOWER
PORTAL	a 4 ft. (~122 cm) wide by 12 ft. 11 in. (~394 cm) deep infinitely tall volume bounded by, and including, 2 in. (~5 cm). ALLIANCE colored gaffers tape and the PORTAL wall.
POWER CUBE	The game piece used to affect the position of the SCALE and SWITCH PLATES, and can be traded in for POWER UPS. A POWER CUBE is a 1 ft. 1 in. (~33 cm) wide by 1 ft. 1 in. (~33 cm) deep by 11 in. (~27 cm) tall HDPE milk crate covered in a yellow nylon (600 Denier) cover
POWER CUBE PILE	The collection of POWER CUBES in a pyramid formation, with six on the bottom, three in the middle, and one on top, justified toward the SWITCH



POWER CUBE ZONE	A rectangular area 3 ft. 9 in. (~114 cm) wide by 3 ft. 6 in. (~107 cm) deep, bounded by the SWITCH and 2 in. (~5 cm) ALLIANCE colored gaffers tape. The POWER CUBE ZONE includes the gaffers tape, but excludes the SWITCH
POWER UP	advantages an ALLIANCE can earn and play throughout the TELEOP stage of the MATCH
RED CARD	a penalty assessed for egregious ROBOT or Team member behavior, or rule violations, which results in a Team being DISQUALIFIED for the MATCH
RETURN	a 1ft. 2 in. (~36 cm) square, centered above the lower opening and is located 1 ft. 8 in. (~51 cm) above the carpet
REFEREE	an official who is certified by FIRST to enforce the rules of FIRST POWER UP
ROBOT	an electromechanical assembly built by the FIRST® Robotics Competition Team to perform specific tasks when competing in FIRST® POWER UP SM . The ROBOT must include all of the basic systems required to be an active participant in the game – power, communications, control, BUMPERS, and movement. The ROBOT implementation must obviously follow a design approach intended to play FIRST POWER UP
RP	Ranking Point, a unit credited to a Team based on their ALLIANCE'S performance in Qualification MATCHES
RS	Ranking Score, the total number of Ranking Points earned by a Team throughout their Qualification MATCHES divided by the number of MATCHES they've been scheduled to play (minus any SURROGATE MATCH), then truncated to two (2) decimal places
RSL	ROBOT Signal Light
RUNG	One of two (2) 1 ft. 1 in. (~33 cm) long 1 ¼ in. Schedule 40 aluminum pipe supported by 2 in. (~5 cm) box tubing. Each RUNG extends 8 ¼ in. (~21 cm) from the vertical face of the SCALE supports and 7 ft. (~213 cm) from the carpet to the top of the RUNG
SCALE	A FIELD assembly that features an arm, RUNGS, PLATES, OUTRIGGERS, PLATFORMS, and TOWER
SIGNAL LEVEL	circuits which draw ≤1A continuous and have a source incapable of delivering >1A, including but not limited to roboRIO non-PWM outputs, CAN signals, PCM Solenoid outputs, VRM 500mA outputs and Arduino outputs
STARTING CONFIGURATION	the physical configuration and orientation of the ROBOT at the beginning of the MATCH where no part of the ROBOT shall extend outside the vertical projection of the FRAME PERIMETER, with the exception of its BUMPERS and minor protrusions such as bolt heads, fastener ends, rivets, cable ties, etc.
STARTING LINE	a line of 2 in. (~5 cm), white gaffers tape that runs the width of the carpet and is 2 ft. 6 in. (~76 cm) behind the ALLIANCE WALL diamond plate
SURROGATE	a Team randomly assigned by the FIELD Management System to play an extra Qualification MATCH
SWITCH	One of two (2) FIELD assemblies centered across the width of the FIELD, with the center of the SWITCH located 14 ft. (~427 cm) from the ALLIANCE STATION
TECH FOUL	25 points credited towards the opponent's total score
TECHNICIAN	a precollege student member of the DRIVE TEAM who is a resource for ROBOT troubleshooting, setup, and removal from the FIELD
TELEOP	the second stage in a MATCH and is two minutes and fifteen seconds (2:15) long
TIMEOUT	a period of up to six (6) minutes between MATCHES which is used to pause Playoff MATCH progression
TOWER	the central structure of the SCALE constructed from aluminum shielded by polycarbonate which supports the RUNGS and SCALE PLATES
VAULT	an aluminum and plastic structure used by HUMAN PLAYERS to turn POWER CUBES in to POWER UPS



VENDOR	a legitimate business source for COTS items that satisfies criteria listed in Section 8.1 Overview
VRM	Voltage Regulator Module
WITHHOLDING ALLOWANCE	a static set of FABRICATED ITEMS that shall not exceed 30 lbs. (~13 kg.), brought to an event (or ROBOT Access Period) in addition to the bagged items, to be used to repair and/or upgrade their ROBOT
YELLOW CARD	a warning issued by the Head REFEREE for egregious ROBOT or Team member behavior or rule violations. A subsequent YELLOW CARD within the same tournament phase will lead to a RED CARD.

